

Book it right and pack it tight

Guidance on packing dangerous goods for carriage
by sea – IMDG Code Amendment 40-20



A Carefully to Carry publication

Jointly published by:

Thomas Miller P&I Ltd
90 Fenchurch Street, London EC3M 4ST
Tel: +44 (0)20 7283 4646
email: lossprevention.ukclub@thomasmiller.com
www.ukpandi.com

Through Transport Mutual Services (UK) Ltd
90 Fenchurch Street, London EC3M 4ST
Tel: +44 (0)20 7204 2626
Email: riskmanagement@ttclub.com
www.ttclub.com

Paperback: ISBN 978-0-9562704-6-7

PDF: ISBN 978-0-9562704-7-4

Acknowledgements

UK P&I Club and TT Club would like to thank Richard Masters for compiling and structuring this detailed guidance, and Will Bartle from Exis Technologies (part of the NCB Group) for acting as editor in chief for this latest version.

Disclaimer

This guide is to assist supply chain stakeholders to understand their key duties under the International Maritime Dangerous Goods (IMDG) Code, but does not attempt to provide comprehensive information on all subject matter in the Code. While we believe the information to be accurate, the publishers will accept no legal liability for any conclusions drawn by any person from the contents. In all operational matters referred to in this guide, the IMDG Code must always be the source of information, as the Code is the legal document. Nor is this guide a substitute for IMDG Code training, which is itself a requirement of the Code.

Copyright © 2022 jointly held by Thomas Miller P&I Ltd and Through Transport Mutual Services (UK) Ltd. All rights reserved. Users of this guide may reproduce or transmit it verbatim only. Any other use, including derivative guidance based on this guide, in any form or by any means is subject to prior permission in writing from the copyright holders.

Foreword

I am pleased to introduce an update on the “Book it right and pack it tight” publication, which reflects the mandatory application of the latest amendment to the International Maritime Dangerous Goods (IMDG) Code from 1 June 2022. In doing so, I applaud the continuing efforts of the UK P&I Club and TT Club to provide useful and practical guides to these vital rules for the carriage of packaged dangerous goods by sea.

While the IMDG Code has existed for approaching six decades, and training has been mandatory since 2004, the consequences of poor understanding and practices continue to reverberate through the maritime supply chain. In particular, the frequency of major ship fires shows little sign of abating and the resultant costs to life, assets and the environment are devastating.

The global freight supply chain comprises a large number of diverse participants; the obligations and responsibilities resting on those who enter cargo into this supply chain, in general terms shippers and packers, are substantial. The IMDG Code is mandatory – forming the maritime element of the overall international dangerous goods regime which is applying to all modes of transport. This is supported by other guidance materials, key amongst which is the IMO/ILO/UNECE Code of Practice for Packing of Cargo Transport Units (CTU Code).

The scale of unitised operations globally is such that great reliance has to be placed on the competence and integrity of each individual and entity involved; the system is based upon trust, which has been sorely strained through the incidents incurred aboard ships and in port areas. The multitude of Vessel Sharing Agreements across the Carriers merely underlines the need for a common and practical understanding of the requirements involved in transport of dangerous goods.

Regardless how sophisticated electronic tools become, it is vital that the people involved at each stage of the process have appropriate understanding and expertise in order not just to carry out their immediate function but also to be able to validate what is presented on a screen. Such diligence is necessary to manage the unforgiving laws of physics and chemistry that govern the nature of the goods carried in ships and stacked in container yards in ports.

This guidance reflects Amendment 40-20 of the IMDG Code. It follows the full range of processes of a dangerous goods consignment being carried by sea.

Dangerous Goods problems at sea start on land, so I urge all involved in the intermodal supply chain – shippers, forwarders, logistics operators, shipping lines – to distribute this publication widely to their own staff, and their counterparties who prepare consignments for mariners to carry.

Uffe Ernst-Frederiksen
Head of Cargo Standards, Maersk Line
Vice Chairman,
International Vessel Operators Dangerous Goods Association (IVODGA)

June 2022

Contents

Introduction	7
Using this guide	8
The International Maritime Dangerous Goods Code	8
The CTU Code – International standard for safe packing of cargo transport units	9
A reminder to those who pack dangerous goods into cargo transport units	10
IMDG code training for shore-based personnel	11
Security of dangerous goods	13
General and non-IMDG restrictions on dangerous goods cargo	13

Part A: Processing a dangerous goods consignment

Step 1: Classification of dangerous goods	
A1 Classification	15
A1.1 Identifying the hazard by classification	15
A1.2 Summary of the UN classification information in this guide	16
A1.3 Level of chemical knowledge required to produce an IMDG compliant consignment and use of safety data sheets	16

Step 2: Selection of packaging	
A2 Importance of appropriate packagings	17
A2.1 Packaging choice and selection	17
A2.2 Packing Instructions	18
A2.3 The Packing Instructions tables	18
A2.4 Packing Provisions	18
A2.5 Packaging for articles classified as dangerous goods	19
A2.6 Types of packagings	19
A2.7 UN testing, approval and marking of packagings	21

Step 3: Marking and labelling of packages	
A3 Marking and labelling of packages	24

Step 4: Preparing the transport document for booking with the shipping line	
A4 Information the shipper is required to present when booking a dangerous goods consignment with a shipping line	26
A4.1 Identification and display of dangerous goods details	26
A4.2 Universal details required in a dangerous goods booking	26
A4.3 Variable cargo details	29
A4.4 The dangerous goods transport document	33
A4.5 Additional certification	34

Step 5: IMDG segregation	
A5 Segregation of incompatible dangerous goods	35
A5.1 Introduction	35
A5.2 Segregation checks when preparing a mixed load dangerous shipment for transport	35
A5.3 Methods for checking the segregation	35
A5.4 The IMDG Code segregation check process	36
A5.5 Segregation group allocation for N.O.S. substances	40
A5.6 Foodstuffs	41
A5.7 Special segregation provisions and exemptions	41

Step 6: Packing the cargo transport unit	
A6 Packing the cargo transport unit	42
A6.1 Pre-packing assessment	42

A6.2	Creating a stow plan for the packers	42
A6.3	Checking the condition of the cargo transport unit	44
A6.4	Packing the cargo transport unit	45
A6.5	Stacking capacity of packages – 20' versus 40' cargo transport unit	48
A6.6	Gap stacking for air circulation	49
A6.7	Packing drummed cargo into cargo transport units	49
A6.8	Packing dangerous goods on pallets	52
A6.9	Solid frame Intermediate Bulk Containers (IBCs)	54
A6.10	Securing the cargo inside the cargo transport unit	56
A6.11	Lashing cargo inside cargo transport units	58
A6.12	The packer's documentation – the packing certificate	58
A6.13	Placarding and marking cargo transport units	58

Step 7: The packing certificate

A7	The purpose of the packing certificate	61
A7.1	Who signs the packing certificate?	61
A7.2	Packing certificate on a combined document	61
A7.3	Legal status of the packing certificate	61
A7.4	Legally binding statement by the cargo consolidator / cargo transport unit packer	62
A7.5	Summary of the provisions of the packing certificate	63

The final objective: Safely loading containers to the ship

	Loading the ship – the role of the cargo planner	64
	Precise and comprehensive information is vital to the plan	64
	Calculating stowage and segregation	65
	Stowage on the ship	65
	Segregation of dangerous goods on the ship	65
	Protecting temperature-sensitive substances from sources of heat	65
	Areas that ship planners must avoid when stowing heat sensitive cargoes	66
	Ship planners depend on the shipper's information to load a safe ship	66
	Conclusion	67

Part B: Reference and Classification

Introduction

B1	What are dangerous goods and how are they identified?	70
B2	Structure of the International Maritime Dangerous Goods (IMDG) Code	70
B2.1	Format of the IMDG Code	71
B2.2	The Dangerous Goods List (numerical index)	71
B2.3	The Alphabetical Index	72
B3	Classification of dangerous goods for transport	72
B3.1	What is classification of dangerous goods?	73
B3.2	Classification by hazard class (IMDG Part 2 – Classes 1 to 9)	73
B3.3	Marine pollutants	83
B4	Subsidiary hazards (sub-hazards)	84
B5	Entries in the Dangerous Goods List: UN numbering system and Proper Shipping Names	84
B5.1	The four types of Proper Shipping Name entries in the Dangerous Goods List	84
B6	Packing groups	86
B7	Articles containing dangerous goods N.O.S.	86
B8	Determination of flashpoints for flammable liquids	87
B9	Special controls for polymerizing and unstable substances stabilized for transport	87
B10	Dangerous goods forbidden for transport	88
B11	Additional certification that may be required from the shipper	88
B11.1	Weathering certificate	88
B11.2	Exemption certificate	88
B11.3	Letter of indemnity	88

B11.4	Competent authority approval	89
B11.5	Tank inspection certificates	89
B12	Provisions for empty uncleaned tank containers	89
B13	Provisions for shipping dangerous goods in Limited Quantities	89
B13.1	General advantages of shipping in Limited Quantities	89
B13.2	IMDG advantages of shipping in Limited Quantities	90
B13.3	Rationality of allowing relaxed rules for Limited Quantities	90
B13.4	Rule variations for dangerous goods in Limited Quantities	90
B13.5	Packaging for Limited Quantities	90
B13.6	Package marking requirements for Limited Quantities	91
B13.7	Documentation requirements for Limited Quantities	91
B13.8	Marking requirements for cargo transport units carrying dangerous goods in Limited Quantities	92
B13.9	Summary of criteria for shipping Limited Quantities	92
B14	Excepted Quantities	92
B14.1	Marking requirements for Excepted Quantities	93
B15	Fumigated cargo transport units	94
B15.1	Purpose of fumigation	94
B15.2	Hazards of fumigation	94
B15.3	Definition of "fumigated cargo transport unit"	94
B15.4	IMDG operational requirements for fumigated cargo transport units	94
B15.5	Applying the fumigant to the cargo transport unit	94
B15.6	Marking of fumigated cargo transport units	95
B15.7	Documentation for fumigated cargo transport units	95
B15.8	Loading fumigated cargo transport units to ships	96

	Case study	
	Liability judgment in 'MSC Flaminia'	97

	References	
	IMDG Code, CTU Code and fumigation guidance	99

	Checklists	101
	Shipper's dangerous goods declaration checklist	102
	Consolidator's dangerous goods training and procedure checklist	103
	Dangerous goods container packer's checklist	104

	About us	
	UK P&I Club	105
	TT Club	105
	Thomas Miller	105

Introduction

As years go by, serious incidents caused by or involving dangerous goods continue to occur, not only on ships but also in ports. Errors, misunderstandings, misdeclarations and inadequate packing and securing lie at the heart of many of these incidents. As ultra-large container ships and the marine terminals they call at increase in size and capacity, the potential for economic, human and environmental accidents rise in proportion.

This guide is intended to support shippers, forwarders, shipping line booking staff and those who pack dangerous goods into cargo transport units for carriage by sea in the technical aspects of the IMDG Code.

It is projected that by assisting parties to understand their own duties and the duties of other actors in the transport chain, both communications and compliance can be enhanced.

This edition reflects the position in the IMDG Code Amendment 40-20 which is mandatory from 1 June 2022 and follows all the steps required when booking and packing a consignment of dangerous goods with a shipping line.

The guide presents the operational steps in Part A, supported by a general reference section in Part B.

Part A of the guide breaks down the process of preparing and booking the cargo into the following steps, and looks at the roles and requirements for the parties involved in each step:

- Step 1: Classification of dangerous goods
- Step 2: Selection of packaging
- Step 3: Marking and labelling the packages
- Step 4: Preparing the transport document for booking with the shipping line
- Step 5: Applying the segregation rules
- Step 6: Packing the cargo transport unit
- Step 7: Producing the cargo transport unit packing certificate

Part B provides background to the IMDG Code and references to further materials.

The IMO/ILO/UNECE Code of Practice for Packing of Cargo Transport Units (CTU Code) has been adopted as non-mandatory international law and is a referenced from the IMDG Code. This guide will refer to the CTU Code as the definitive industry guidance document on how to pack and secure cargo of all types in cargo transport units.

Using this guide

This guide is intended to help shippers, shipping line booking staff, and those who pack dangerous goods into cargo transport units to get an overview of their key practical duties under the IMDG Code and does not seek to meet the mandatory training requirements.

This guide consists of Part A and Part B

Part A

This covers the operational processes and documentation involved in preparing and presenting a consignment of dangerous goods for shipment. Part A uses terms from the IMDG Code that are explained in the reference section, Part B.

Part B

This is a reference section that explains the basic principles of the UN classification system, the technical terms used in the IMDG Code, and provides useful background information on common IMDG issues such as Limited Quantities procedures.

The IMDG Code is a lengthy manual set out in the same UN intermodal documentary format as other UN transport model regulations based on part, chapter, section, and sub-section numbers to identify the location of information within the document. IMDG Code text references appear in this guide to take readers to the relevant place in the IMDG Code text where the full details will be found. For example, reference IMDG 5.4.1.4. refers to Part 5, Chapter 4, Section 1, Sub-section 4, titled *“Information required on the dangerous goods transport document.”*

International Maritime Dangerous Goods (IMDG) Code

The International Maritime Dangerous Goods (IMDG) Code governs the processes by which dangerous cargoes may be transported by sea. It was first published by the International Maritime Organization (IMO) in 1965. Since January 2004 the Code has been mandatory for SOLAS (Safety of Life at Sea Convention) signatory states, effectively making it a global rulebook for the sea transport of dangerous goods.

Although it is directed primarily at sea transport, the provisions of the Code affect a broader range of industries and services – manufacturers, packers, shippers, inland transport operators (road, rail and inland waterway), port authorities and terminal operators. The IMDG Code is based on the same ‘Orange book’ (UN Recommendations on the Transport of Dangerous Goods – Model Regulations) as other modal dangerous goods regulations. IMDG provides authoritative advice on classification, stowage, segregation, packing, labelling, terminology and emergency response action.

Unfortunately, the number of incidents involving dangerous goods worldwide tells us that the rules are not universally followed. Factors such as desire to save cost, lack of knowledge and training, and failure in communications between geographically distant actors in the transport chain, conspire to create the potential for errors.

This guide provides an overview on the key provisions and considerations of the IMDG Code when shipping dangerous goods by sea, and provides guidance if common errors are to be avoided. Much depends on the skill and awareness of the personnel packing the shipping containers – skills that are often under-rated and under-valued.

Any person or organisation offering dangerous goods or packing cargo transport units that do not comply with the IMDG Code, or follow the guidance provided in the CTU Code, is in a precarious position if that non-compliance leads to an incident. It can put lives at risk, and lead to property and environmental damage. The party responsible will be liable to prosecution, fines by national maritime enforcement agencies and to civil court actions to compensate other actors for costs incurred arising from damage to the ship, cargo and environment, injury and loss of earnings, etc. See the case study from ‘MSC Flaminia’ incident – pages 97-98.

The CTU Code

International standard for safe packing of cargo transport units

Properly known as “The 2014 IMO/ILO/UNECE Code of Practice for Packing of Cargo Transport Units”, the CTU Code was developed by the IMO (International Maritime Organization), the ILO (International Labour Organization) and UNECE (United Nations Economic Commission for Europe) to provide global non-mandatory recommendations on best practice for handling and packing cargo transport units for transport by road and sea. The CTU Code and accompanying materials were approved by the UN agencies during 2014.

Poor packing practices and improperly secured loads give rise to a majority of incidents along the international transport supply chain, resulting in damage, loss and injuries on land and at sea.

It is recognised that there has been a lack of guidance and training materials for personnel at the “sharp end” of the cargo handling industry, and the CTU Code sets out to address this.

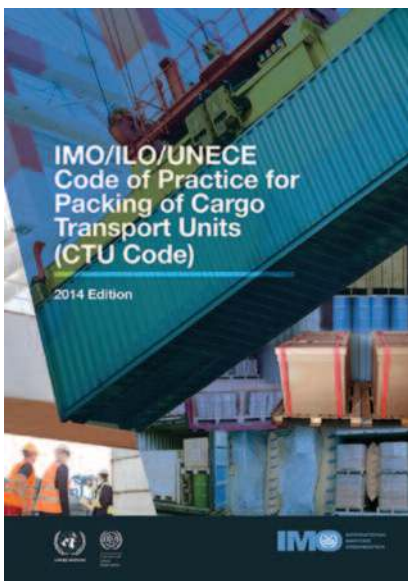

Within the CTU Code, comprehensive information and references on all aspects of packing and securing of cargo in containers and other intermodal transport units are provided, taking account of the requirements of sea and land transport modes. The CTU Code applies to transport operations throughout the entire intermodal transport chain and provides guidance not only to those responsible for packing and securing cargo, but also to those who receive and unpack such units. The Code of Practice also addresses issues such as training and the packing of dangerous goods.

The CTU Code and related material is freely available from the UNECE searchable website at <https://wiki.unece.org/display/TransportSustainableCTUCode/CTU+Code>

and the IMO at <https://www.imo.org/en/OurWork/Safety/Pages/CTU-Code.aspx>

Cargo Integrity Group

A group of industry entities is collaborating to improve standards for the safe and secure packing of cargoes in cargo transport units and the avoidance of contamination by invasive pests. Since January 2022 the group comprises Bureau International des Containers et du Transport Intermodal (BIC), Container Owners Association (COA), International Federation of Freight Forwarders Associations (FIATA), Global Shippers Forum (GSF), International Cargo Handling Co-ordination Association (ICHCA International), TT Club and World Shipping Council (WSC).

This group published ‘CTU Code – a quick guide’ as a route-map for the broad industry to engage more successfully with the CTU Code and to assist wider understanding of good packing practices. A complementary Container Packing Checklist sequences the main check-points from a container packer’s perspective, supporting sound decision-making. Successful completion facilitates safe and secure dispatch of a container, and avoidance of pest contamination based on CTU Code.

Further information can be found at <https://www.ttclub.com/loss-prevention/cargo-integrity/>

A reminder to those who pack dangerous goods into cargo transport units

If you are responsible for classifying, packaging, declaring and documenting dangerous goods, or packing them into a cargo transport unit, you have a legally binding duty to do so in accordance with the rules of the IMDG Code.

To assist with packing and securing all types of cargo into cargo transport units extensive practical guidance is now freely available in the CTU Code.

If you are the packer it is your responsibility to ensure that any dangerous goods dispatched by you for maritime transport are correctly identified, labelled and segregated, and secured inside the cargo transport unit so that they cannot move, that packages will not collapse or otherwise be damaged, allowing product to leak or escape from the packaging during carriage, and you must certify that you have complied with this responsibility by issue of a signed packing certificate.

Failure by packers to carry out this safety critical operation in compliance with the IMDG Code will have serious financial and legal consequences for those responsible in the event of that non-compliance being the cause of an incident.



IMDG Code training for shore-based personnel

Training is a key requirement of the IMDG Code (see IMDG Chapter 1.3 for the training requirements)

Duties to train employees

If your organisation is involved in packaging or shipping dangerous goods, preparing or processing dangerous goods transport documents, or packing dangerous goods into cargo transport units, your personnel must understand the provisions in the International Maritime Dangerous Goods (IMDG) Code. To follow these provisions your personnel need to be trained to understand them and the reasons for them. Chapter 1.3 of the IMDG Code has detailed guidance on what training is required for specific job functions.

In addition to specific IMDG Code requirements, most countries also have domestic legislation that creates an employer's duty of care to provide training in safety critical operations for the safety of their employees and others, which of course includes the handling and packing of dangerous goods for maritime and other modes of transport.



Depending on their role, your staff may be required to understand the following:

- The legal responsibility to identify dangerous goods accurately
- Where to locate required information in the IMDG Code
- How to identify different classes of dangerous goods
- How dangerous goods data should be presented on a transport document and what that data means
- How packages should be marked and labelled
- How to make up, mark and label dangerous goods in palletised unit loads
- The IMDG Code segregation rules for the separating of dangerous goods that have the potential to react with each other
- How to stow and secure packages of different types and sizes in cargo transport units so the packages will not slide, roll or collapse under the weight of over-stowed cargo during the sea journey
- The rules for placarding and marking shipping containers
- The legal responsibility accepted by the packer by signing a packing certificate.

Full operational competence can only be achieved by providing appropriate training consistent with the employee's level of control and responsibility in the transport chain. It is essential that supervisory employees are trained to understand the IMDG Code rules, and have access to the rules for reference, as different substances require different handling; that those with the responsibility for compliance must be given the knowledge and authority to maintain procedures that ensure the provisions of the IMDG Code are carried out operationally.

IMDG Code dangerous goods training guide for shore-based staff

IMDG Chapter 1.3 indicates that shore-based personnel involved with dangerous goods should have training appropriate to their job role and level of responsibility in one or more key areas. Records of all training should be kept by the employer.

- 1. General awareness/familiarisation training¹** – all persons should be trained to be familiar with the general provisions of the transport of dangerous goods, including the classes, labelling, marking, placarding, packing, segregation and compatibility, the purpose of the dangerous goods transport document and the container/vehicle packing certificate.
- 2. Function-specific training²** – persons must be trained in the specific dangerous goods transport provisions that are applicable to the function(s). A guide to what provisions are applicable to specific job functions is provided in the table in IMDG 1.3.1.6.
- 3. Safety training³** – commensurate to the risk of exposure in the event of a release of dangerous substances and the functions involved, persons involved in the handling of dangerous goods, or located in the vicinity of where they are handled, should be trained in:
 - Procedures for accident avoidance such as proper control of cargo handling equipment and appropriate stowage of packages
 - Available emergency response information and how to obtain it
 - General dangers presented by the various classes of dangerous goods, how to avoid exposure and where applicable, how to use or wear appropriate Personal Protective Equipment (PPE)
 - Immediate procedures to be followed in the event of an unintentional release of dangerous goods to protect self and others.

IMDG Recommendations for training shore-based personnel

There is a useful table in IMDG 1.3.1.5 which identifies functions that shore-based personnel carry out, and provides specific training recommendations for those engaged in that function.

¹ IMDG Code, 2020 Edition Amendment 40-20, Section 1.3.1.2.1

² IMDG Code, 2020 Edition Amendment 40-20, Section 1.3.1.2.2

³ IMDG Code, 2020 Edition Amendment 40-20, Section 1.3.1.4

Security of dangerous goods⁴

Shippers and shipping line staff should be aware that ships, ports and container terminals are key infrastructure elements and are potential terrorist targets. They are subject to the provisions of the International Ship and Port Facility Security (ISPS) Code that requires ship and port operators to take precautionary measures to defend against acts of terrorism.

High Consequence Dangerous Goods (HCDG)

Certain types of dangerous goods have been identified as having significant potential for misuse by terrorists intending to instigate an event leading to mass casualties or mass destruction.

Shore-based staff employed by organisations handling HCDG should be aware of the increased risk factor, and maintain a security plan to defend against terrorists taking advantage of the destructive potential of such dangerous goods.

The security plan should include security training to ensure employees adopt practical measures to identify, report and reduce security risks, and to keep critical transport information confidential.

High consequence dangerous goods include some of the higher risk substances and articles in Classes 1, 2, 3, 4, 5.1, 6 and 8. The list of specific items and details of the type of defensive measures to be taken are found in IMDG 1.4.3.

Not all bookings for all dangerous goods can be accepted for all ships and all routes. Full details will be required from the shipper in the first instance.

Many ships are restricted as to the types and volume of dangerous goods they can carry because of ship design or insurance restrictions, particularly so in the case of explosives and radioactive materials which also have special stowage requirements.

Most ports restrict handling and transit of explosives and radioactive materials where safety, security, social and political factors are weighed beyond the practicalities of marine transport. Volumes shipped of these commodities are relatively low, and carried out by specialists. Therefore, only the basic IMDG Code requirements of both explosives and radioactive materials will be dealt with in this guide.

Many ports restrict other types of dangerous goods (e.g. ammonium nitrate) for safety reasons. To determine whether the line can accept the dangerous goods booking, and whether any special conditions or volume restrictions will apply, the shipper will need to supply the information below. Based on the type of dangerous cargo, the rules of the ports of transit and discharge, and the class of ship available, the booking will be either rejected or accepted and passed on to the next stage.

General and non-IMDG restrictions on dangerous goods cargo

⁴ IMDG Code, 2020 Edition Amendment 40-20, Chapter 1.4

Part A: Processing a dangerous goods consignment

Step 1: Classification of dangerous goods

A1 Classification

It is fundamental for safety in the transport chain that detailed information on the hazards presented by any dangerous goods are known and readily available for all parties involved in the carriage. Therefore, the first key task of a shipper of dangerous goods is to identify the hazard that his dangerous goods present by carrying out the correct UN classification.

A1.1 Identifying the hazard by classification

The UN Manual of Tests and Criteria contains criteria, test methods and procedures to be used for classification of dangerous goods for transport in all modes, and of chemicals presenting physical hazards according to the Globally Harmonized System of Classification and Labelling of Chemicals (GHS).

These test methods include laboratory procedures for establishing explosivity, toxicity of liquids, gases and solids, flash points of flammable liquids, temperature thresholds for flammable solids and self-reactive substances, stability of peroxides, degree of corrosivity of acids and alkalis, propensity of substances to polymerize, environmental damage potential and many other hazardous characteristics.

At the end of the process, dangerous goods are classified into one of nine hazard classes, allocated a formal Proper Shipping Name and UN identification number, and where applicable, graded by packing group into high, medium or low hazard. Where substances have more than one hazard, all the hazards should be identified in the Proper Shipping Name but the most significant hazard, in accordance with the Table for Precedence of Hazards⁵, takes prominence.

Classification and hazard identification of the most commonly shipped base chemicals are well established. Shippers of these will have manufacturer's authenticated laboratory test reports available and will not need to repeat those tests.

However, shippers of products consisting of innovative combinations of two or more chemicals whose hazardous characteristics are not established will need to arrange for tests to be done that identify the hazard class(es) and UN Number according to the UN Manual of Tests and Criteria before the substance can be offered for sale and transport. They cannot be accurately documented for the IMDG Code or other transport modes until those tests are done, except as small samples dispatched for test purposes.

Shippers that design and develop chemical products would normally have personnel with the required skills to test and classify their own products to UN criteria, but shippers who only buy and sell dangerous substances need to obtain the hazardous classification from the original manufacturer in the form of a Safety Data Sheet. This will contain the information required for the dangerous goods transport document.

⁵ IMDG Code, 2020 Edition Amendment 40-20, Section 2.0.3.6

A1.2 Summary of the UN classification information in this guide

Section B, the reference section to this guide (the tinted pages) explains the principles of the UN classification system as used in the IMDG Code (and other UN transport protocols). The laboratory methods used to identify the hazard classification of a substance are outside the scope of this guide, and the hazard classification process for a substance is done by specialists.

All dangerous goods are classified⁶ by analysis into one of nine hazard classes:

Class 1 – Explosives

Class 2 – Gases

Class 3 – Flammable liquids

Class 4 – Flammable solids; substances liable to spontaneous combustion; substances which, in contact with water, emit flammable gases

Class 5 – Oxidizing substances and organic peroxides

Class 6 – Toxic and infectious substances

Class 7 – Radioactive material

Class 8 – Corrosive substances

Class 9 – Miscellaneous dangerous substances and articles (Class 9) and environmentally hazardous substances

One very significant classification criteria is the Packing Group. This indicates the overall degree of danger presented by the substance, and influences the size and type of packaging options available:

Packing Group I – high degree of danger

Packing Group II – medium degree of danger

Packing Group III – low degree of danger

A1.3 Level of chemical knowledge required to produce an IMDG compliant consignment and use of safety data sheets

It is necessary to have a professional knowledge of chemistry to carry out many of the UN tests to initially classify a dangerous substance, but once that classification has been obtained the classification details are entered on the safety data sheet, which are made freely available by manufacturers.

However, a key point of the IMDG Code is that specialised knowledge of chemistry is not required to produce an IMDG compliant consignment. Given access to the classification details in the safety data sheet, any person trained to understand the layout and meaning of the IMDG Code can prepare a legally compliant dangerous goods transport document, can check that the packaging is suitable, and can mark and label the packages correctly, ready for packing into a cargo transport unit.

All stakeholders need to exercise care to ensure that the safety data sheet is accurate and current. There are many instances of forged or otherwise inappropriate data sheets being presented.

⁶ IMDG Code, 2020 Edition Amendment 40-20, Part 2

Step 2: Selection of packaging

A2 Importance of appropriate packagings

Having classified the dangerous substances and identified their chemical hazards, it is important for the shipper to ensure that the product is contained within safe and stable packaging.

IMDG Part 4.1 contains the general provisions that define packagings, including intermediate bulk containers (IBCs) and large packagings, suitable for containing dangerous goods.

The key requirements for safe packagings

- Strong enough to withstand the shocks and loadings of transport and all types of handling
- Designed to prevent loss of content owing to variations in pressure, temperature or humidity
- Not be weakened by contact with the product
- Not reactive with the product to cause a dangerous reaction or affect the quality of the product
- In use, the package filler must follow the package manufacturer's closure procedures so as to ensure effective closure and prevent loss of contents.

For carriage by sea, the IMDG Code requires that packagings (including large packagings, IBCs, tanks and MEGCs) used for dangerous substances and articles must conform to a type successfully tested in accordance with IMDG Part 6, "Construction and testing of packagings". This provides details on the design and construction of types of packaging, and the individual test standards to which they must conform under the UN packaging testing scheme.

Dangerous substances presented in packaging that is not UN-tested are not acceptable for shipment by sea, unless specifically permitted by the Code. For example, UN-tested packages are not required for goods shipped as Limited Quantities or Excepted Quantities, but the packaging must still meet the general safety provisions of Part 4.

Packagings that have met these standards are conventionally referred to as "UN tested" or "UN approved" packagings.

These standards apply equally to new, reused and reconditioned packagings used for dangerous goods.

A2.1 Packaging choice and selection

Selection of suitable packagings, ensuring any special packing provisions are considered and correct filling of them is the shipper's legal duty. Packaging selection for individual products within a particular class will vary depending on the chemical nature of the product, and the shipper is required to take that into account when selecting packaging. At all times, unless specifically exempted, the packaging must comply with the general and type-specific UN packaging instructions described in IMDG Part 4.

The shipper's declaration on the transport document includes a statement certifying that the dangerous goods have been correctly packaged according to the IMDG Code provisions. For example, if a shipper has a liquid product that is corrosive to steel, the packagings he chooses may be steel drums approved for liquids under the UN system for the carriage of liquids, but the shipper must ensure the steel is lined or coated and certified to be resistant to the corrosive nature of his individual product.

Instructions for the correct use of standard packagings such as boxes, drums, jerricans and bags, as well as IBCs, large packagings, pressure receptacles for gases

(cylinders and multi-element gas containers), portable tanks and bulk containers and they how shall be used are described Packing Instructions set out in IMDG Chapter 4.1, 4.2 and 4.3 respectively, which describe the uses of packagings.

A2.2 Packing Instructions

The majority of entries in the dangerous goods list are assigned packing instructions. These are numbered and shown in separate columns for standard packages and gas cylinders, IBCs, and portable tanks (tank containers) respectively.

- **DG List Column 8** indicates Packing Instructions for standard packages such as boxes, drums, jerricans, bags and large packages, providing the range of packaging types that are available to a shipper for the product.
- **DG List Column 10** has codes for Packing Instructions for the types of Intermediate Bulk Containers (IBCs) that may be used.
- **DG List Column 13** has codes for Tank Instructions for the types of portable tanks or bulk containers that may be used.

A2.3 The Packing Instructions tables

IMDG Part 4.1 contains tables listing each Packing Instruction and setting out the details of each one. Where individual substances require specialised or a restricted range of packaging, Packing Provisions are allocated. Packing Provisions are allocated to individual UN Numbers, and are attached to the Packing Instruction tables.

For quick reference, the Packing Instructions are arranged as follows:

- Packing Instruction numbers P001 – P911 apply to standard packagings, boxes, drums, jerricans, bags, gas cylinders and packaging for articles such as batteries.
- Packing Instructions IBC01 – IBC08, IBC99, IBC100, IBC520 and IBC620 apply to IBCs.
- Packing Instructions LP01 – LP03, LP99, LP101, LP102, LP200, LP621, LP622, LP902 – LP906 apply to Large Packagings.
- IMDG Part 4.2 contains Tank Instructions and Tank Provisions that define how portable tanks and Multi Element Gas Containers (MEGCs) are used.
- IMDG Part 4.3 has instructions for the use of bulk containers, where no intermediate packaging is used, and the product is packed directly into a cargo transport unit.

A2.4 Packing Provisions

Sometimes the nature of an individual substance has special characteristics requiring that packaging is restricted in size, or is qualified or required to be adapted over and above the general standard in order to maintain safety. This is shown in additional Packing Provisions set out in the Dangerous Goods List adjacent to the relevant Packing Instruction as follows:

- **DG List Column 9** has codes for Packing Provisions applicable to standard packagings (including large packagings) – boxes, drums, jerricans and bags etc.
- **DG List Column 11** has codes for Packing Provisions applicable to IBCs.
- **DG List Column 14** has codes for Tank Provisions applicable to tanks, multi-element gas containers and bulk containers.

A2.5 Packaging for articles classified as dangerous goods

Articles classified as dangerous goods may not be required to be packaged in UN tested packaging, but the individual entry in the Dangerous Goods List must be checked.

For example, Packing Instruction P003 applies to UN 2800, BATTERIES, WET, NON-SPILLABLE and only requires the batteries to be placed in "suitable outer packagings" that do not need to be UN-tested. However, the Special Packing Provision PP16 applies and requires the batteries to be "protected from short circuit" within the packagings.

In contrast, Packing Instructions P903, P908, P909, P910, P911, LP903, LP904, LP905 and LP906 apply to UN 3090, LITHIUM METAL BATTERIES and require the batteries to be packaged in UN-tested packages meeting the test criteria for Packing Group I (P911 and LP906) and Packing Group II performance level, unless exempted by Special Provisions elsewhere in the Code.

A2.6 Types of packagings⁷

Packagings take many forms and may be constructed from a variety of materials or combination of materials. The provisions for these are available in 6.1.4 for conventional packagings, e.g. steel drums, fiberboard boxes, 6.5.1.4 for IBCs and 6.6.2 for large packagings and are summarised below.

Composite packagings

Are made of two or more elements that are designed to be used together and not separated, and may be permanently bonded together e.g. steel drums may have a permanently bonded plastic inner receptacle for extra strength and resistance to the effect of corrosive products, or multi-layer bags or flexible IBCs may have a sift-proof plastic inner liner(s) inside a tear-resistant woven outer layer.

Combination packagings

Are those that have independent removable inner packagings containing the product placed inside an outer packaging that may be fibreboard, wood or plastic, often with shock absorbing and absorbent material between the two elements. Combination packagings are not designed to be opened during transport. Combination packagings are tested with the inner packagings filled with product or comparable substitute inside the outer packaging in the form in which the package will be used.



Construction of a typical combination package for dangerous goods: Separate inner packagings packed inside a fibreboard outer packaging

Boxes

Fibreboard boxes with inner packagings made of plastic for liquids or solids are one of the most common packagings for dangerous goods.

Boxes may also be made of steel, aluminium or other metal, wood, plywood, reconstituted wood, and solid or expanded plastics, and generally have inner packagings that are in contact with the dangerous goods.

⁷ IMDG Code, 2020 Edition Amendment 40-20, Section 6.1.4

The maximum net mass for different types of boxes varies according to box design and Packing Group. The maximum net mass for a box containing dangerous goods of Packing Group II or III is 400 kg.

Drums

Drums are defined as cylindrical packagings, generally but not necessarily with flat ends. They are produced in a wide variety of sizes and may be manufactured from steel, aluminium or other metal, plastic, plywood or fibre. They may be single packagings, combination packagings with removable inners, or composite packagings with non-removable inner liners.

The maximum net mass for a drum containing any dangerous goods of Packing Group II or III is 400 kg. The maximum net mass for different types of drum varies according to design and Packing Group, and are shown in the individual packing instructions.

Jerricans

Jerricans are defined as rectangular or polygonal packagings and can be up to 120 kg capacity. They are commonly made in smaller sizes, 5 kg up to 30 kg net mass, with carrying handles for convenient manual handling and retail sale.

Handles are frequently moulded into the top of the package, sometimes preventing them from nesting vertically, and care must be taken with some designs when stacking them because they are prone to collapse if over-stowed, and separator boards between tiers to spread the weight are recommended.

Bags

Bags are suitable for some solid dangerous goods of Packing Groups II and III, and they may be made of plastic film, multi-wall paper or woven textile, and can be supplied with a variety of inner linings. They may be up to 50 kg capacity, but 25 kg is more common. Care is needed during manufacture and closure after filling to achieve sift-proof secure stitched seams or welded seams.

Intermediate Bulk Containers (IBCs)⁸

IBCs are designed for mechanical handling. They can be rigid or flexible and can be up to 3 cubic metres capacity, although the most common are about 1 metre x 1 metre x 1 metre and about 1 tonne gross weight for easy mechanical handling and packing into cargo transport units.

Rigid IBCs are commonly of composite design with a plastic inner receptacle in a metal outer cage. All-metal IBCs can be very robust and be designed for filling or discharging liquids or solids under gravity or pressure. Flexible IBCs are usually made of woven plastic fabric, may be lined with impermeable inner layers and have handles for lifting. Commonly called "big bags" – these are generally certified for one trip only and are non-returnable units.

Reusable metal, rigid and composite IBCs need to be periodically inspected to ensure conformity with design type, internal and external condition and functionality of service equipment. Operators must examine IBCs before they are put into service, then after 2.5 years and after 5 years. Inspection reports must be documented and kept by the owner/operator.

Large packagings⁹

These are also designed for mechanical handling and are defined as an outer packaging intended to contain articles or inner packagings. They exceed 400 kg net mass or 450 litre capacity but have a volume of not more than three cubic metres.

Large packagings can also be rigid or flexible, with rigid packagings commonly being manufactured from steel, aluminium or other metal and flexible large packagings from plastics or paper.



Typical rigid composite IBC



Flexible IBCs

⁸ IMDG Code, 2018 Edition Amendment 39-18, Chapters 4.1 and 6.5

⁹ IMDG Code, 2020 Edition Amendment 40-20, Section 6.6.4

Refillable receptacles for gases (gas cylinders)¹⁰

Individual refillable gas cylinders are marked and labelled with the UN Number and class label in the normal way, and may be stowed in shipping containers. Gas cylinders are subject to variable construction and use requirements, and are subject to inspection and testing every five or ten years, contingent upon the type of gas – see IMDG Chapter 6.2 for further information.

Pressurised gas cylinders have a unique marking system owing to their specialised construction requirements (they are often suitable for one type of gas only), long working life, and extreme stresses which they must withstand. Shippers should ensure that gas cylinders are subject to the appropriate inspection regime based on the UN system, or an alternative national test regime, acceptable under UN terms.

Internal valves should be effectively closed and designed so they cannot release product as a result of vibration, pressure or temperature change. Removable valves should be detached from the cylinders for transport. Where external cylinder valves are part of the cylinder design, valves should be protected from impact by guards or shrouds. If this cannot be done the cylinders should be packed in frames that provide impact protection for the valves.

A2.7 UN testing, approval and marking of packagings

With very few exceptions (packagings used for 'Limited Quantities' or 'Excepted Quantities' consignments being the most notable) dangerous goods transport packagings must be constructed, tested and approved to United Nations (UN) performance standards.

Under the UN packaging specification scheme, samples of a packaging design type are subjected to a series of standard tests – such as being dropped, stacked and subjected to pressure – which simulate predictable transport situations.

The objective is to prove the competence of the packaging design and materials of construction for carrying dangerous goods.

Separate chapters in Part 6 of the IMDG Code describe the testing regime. By way of example, Section 6.1.5 identifies the UN tests which must be carried out on the following packaging types: drums, jerricans, boxes, bags and composite packagings.

Tests must be successfully completed before the packaging can be used for dangerous goods. Once completed a test report and certificate of approval is issued for the packaging design type.

Where a packaging conforms to one or more than one tested packaging design type, including one or more than one tested IBC or large packaging design type, the packaging may bear more than one mark to indicate the relevant performance test requirements that have been met.



Certification can only be granted by a competent authority or an organisation designated for this purpose by a competent authority. The certificate specifies an alphanumeric UN packaging mark similar to the example illustrated left.

The UN packaging mark is subsequently applied by the manufacturer to every packaging made to the tested and approved specification. It identifies certain constraints on the use of the packaging which the consignor must take into account when deciding how to pack the substance being shipped.

But what does this alphanumeric code mean?

¹⁰ IMDG Code, 2020 Edition Amendment 40-20, Chapters 4.1 and 6.2

Markings for packagings¹¹

Examples of the alphanumeric UN packaging marks used to identify a number of common packaging types are illustrated and explained below.

Steel drum – 1A1

The first '1' identifies the packaging as a drum and the 'A' identifies it as being made from steel. The second '1' identifies that this is a non-removable head drum.



Plastics drum – 1H2

The '1' identifies the packaging as a drum and the 'H' identifies it as a plastics drum. The '2' identifies that it has a removable head drum.



Fibreboard box – 4G

The '4' identifies it as a box and the 'G' identifies it as being made from fibreboard.

Further information on the codes used for different packagings can be seen in Section 6.1.2.

Example packaging mark:

 **1B2/X50/S/16 USA/LR235**

	UN approved
1B2	Aluminium drum with removeable head
X	Tested for packing groups I, II and III
50	For packagings intended to contain solids or inner packagings, the maximum gross mass in kilograms.
S	The packaging is intended for the transport of solids or inner packagings or, for packagings (other than combination packagings) intended to contain liquids
16	Year of manufacture
USA	Authorizing state
LR235	Name of manufacturer or other packaging identification

IBC and large packagings marking¹²

A similar marking system is used for IBCs and large packagings that have been manufactured to a UN tested and approved design specification. The packaging code options used for IBCs are:

- rigid, identified by the numbers '11' and '21' for solids, and '31' for liquids; or
- flexible, identified by the number '13'.

¹¹ IMDG Code, 2020 Edition Amendment 40-20, Sections 6.1.2 and 6.1.3

¹² IMDG Code, 2020 Edition Amendment 40-20, Sections 6.5.2 and 6.6.3

This number is combined with a code identifying the material(s) of construction. For example, the code for a rigid IBC made from steel and designed to carry a liquid is 31A ('31' for 'rigid for liquids' and 'A' for 'steel').

Example IBC packaging mark:

 **11A/Y/02 14/CAN/ABC 4-001/5500/1500**

	UN approved
11A	Rigid steel IBC
Y	Designed for packing groups II and III
0214	Month and year of manufacture (Feb 2014)
CAN	State authorizing allocation of the mark (Canada)
ABC 4-001	Name or symbol of the manufacturer and any other identifying mark
5500	Stacking test load in kilograms
1599	Maximum permissible gross mass in kilograms

Full details of the applicable markings can be found in 6.5.2.

For large packagings there are only two packaging codes used:

- 50 – Rigid
- 51 – Flexible

Example large packaging mark:

 **50A/X/05 15/N/PQRS/ 2500/1000**

	UN approved
50A	Rigid large steel packaging
X	Tested for packaging groups I, II, and III
0515	Month and year of manufacture (May 2015)
N	State authorizing allocation of the mark (Norway)
PQRS	Name or symbol of the manufacturer and any other identifying mark
2500	Stacking test load in kilograms
1000	Maximum permissible gross mass in kilograms

Full details of the applicable markings can be found in Section 6.6.3.

Step 3: Marking and labelling of packages

A3 Marking and labelling of packages

Safe transport and handling procedures can only be maintained during the transport of dangerous goods by sea if everyone involved has ready access to information about the risks presented by the goods concerned – container packers/handlers, the ship's crew, the emergency services etc.

Appropriate and readily recognisable warnings on packages can help achieve this objective.

The IMDG Code requires a range of warnings – in the form of marks and labels – to be applied to packages being shipped by sea.

It is the consignor's (shipper's) duty to ensure that packages containing dangerous goods display all the marks and labels required for the sea journey.

The term 'marking' refers to the application of:

- UN Number (Section 5.2.1.1)
- The Proper Shipping Name (PSN) (Section 5.2.1.1)
- Marine pollutant mark (as applicable) (Section 5.2.1.6)
- Orientation marks (as applicable) (Section 5.2.1.7)
- Limited quantity mark (as applicable) (Section 3.4.5)
- Excepted quantity mark (as applicable) (Section 3.5.4)
- Any class or substance specific marks (as applicable) – see Section 5.2.1 for specific details

The term 'labelling' refers to the application of:

- the hazard class diamond label (Section 5.2.2)
- sub-hazard diamond labels (as applicable) (Section 5.2.2)
- any class specific label (as applicable) – see Section 5.2.2 for specific details

Let's look at an example:



Here we can see the following marks and labels:

UN Number : UN 2826

PSN : ETHYL CHLOROTHIOFORMATE

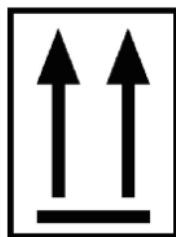

Orientation mark



Marine pollutant mark

Note: in the image above you can also see the UN Packaging mark in the bottom left hand corner (4G/X100/S/04USA/ALC), as described in section A2.7 above.



Class 8 label and Class 3 sub-hazard labels

When applying marks and labels the following provisions must be adhered to:

The required marks and labels only need to be displayed once on a package, *except* as follows:

- IBCs exceeding 450L capacity and large packagings must be marked and labelled on two opposite sides
- Orientation arrows (where required – see Section 5.2.1.7) must always be displayed on two opposite sides

On a combination packaging, the relevant transport marks and labels are only required on the outer packaging e.g. fibreboard box; they are not needed on inner packagings.

For unpackaged articles, the marks and labels must be displayed on the article itself or on its cradle or handling, storage or launching device.

Both marks and labels must still be identifiable on packages surviving at least three months' immersion in the sea.

Wherever possible, marks and labels must be located on the same surface of the package and not be obscured by any part of the package or attachment to it. Any subsidiary hazard label(s) must be displayed next to the primary hazard label.

Labels must satisfy the provisions in Section 5.2.2.2 and conform, in terms of colour, symbols, numbers and general format, to the specimen labels shown in Section 5.2.2.2.2. They must be in the form of a square set at an angle of 45° (diamond-shaped) with minimum dimensions of 100 mm by 100 mm, except in the case of packages of such dimensions that they can only bear smaller labels – see Section 5.2.2.1.1 for an illustration of this.

The label may include text such as the UN Number, or words describing the hazard class (e.g. “corrosive”) provided the text does not obscure or detract from the other required label elements.

Limited Quantity and Excepted Quantity marks

Packages shipped in accordance with the provisions for “Limited Quantities” or “Excepted Quantities” are not subject to the standard marking and labelling requirements highlighted above. They do not need to be marked with the PSN and UN Number of the contents or a marine pollutant mark and no danger or subsidiary hazard labels are needed. Instead they have their own specific identifying marks as follows:

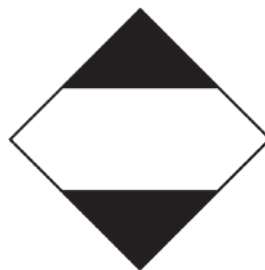

Limited Quantity mark



Excepted Quantity mark

* Class number to be shown here

** Name of the consignor or of the consignee to be shown here if not elsewhere on the package

Note: as well as ensuring that packagings are marked and labelled to identify the hazards contained within, the CTU containing the packagings must also, in most instances, bear similar identifying marks and large labels, known as placards – see Section A6.13.

Step 4: Preparing the transport document for booking with the shipping line

A4 Information the shipper is required to present when booking a dangerous goods consignment with a shipping line

The section looks at the dangerous goods details in the shipper's declaration that the shipper should supply to the shipping line when making the original cargo booking and provides examples where appropriate. It also indicates the way that information must be presented on the final transport document that is presented to the cargo transport unit packer (who will complete and sign the packing certificate section) and the shipping line.

The shipping line booking staff who receive this information will process it and accept or reject the cargo on the strength of the information provided. If the information conflicts with the IMDG Code requirements the booking will be rejected.

A4.1 Identification and display of dangerous goods details

The dangerous goods details are specified in various sections of the IMDG Code, but the details required for the cargo booking and transport document are found in IMDG Part 5 and the Dangerous Goods List.

The details required will vary according to the type of dangerous goods.

A4.2 Universal details required in a dangerous goods booking

This section contains the cargo details that are common for every dangerous goods shipment:

UN Number¹³

The four-digit number in Column 1 of the Dangerous Goods List with the letters "UN" placed in front:

As it appears on shipper's declaration: "UN 2022".

Proper Shipping Name¹⁴

The name of a substance or article shown in Column 2 of the IMDG Dangerous Goods List.

As it appears on shipper's declaration: "UN 2022, CRESYLIC ACID".

OR

Not Otherwise Specified (N.O.S.) Proper Shipping Name¹⁵

N.O.S. generic names are used to describe a shipper's own mixture or solution of dangerous goods that are not listed in the Dangerous Goods List.

To complete an N.O.S. Proper Shipping Name, the technical name(s) of the hazardous components in the mixture must be specified and added in brackets after the generic name. Not more than the two constituents which most predominantly contribute to the hazard or hazards of the mixture or of the articles need to be shown.

The transport document displays N.O.S. entries as the generic description shown in column 2 (selected from IMDG Code Appendix A) followed in brackets by the variable hazardous components.

As it appears on the shipper's declaration: "UN 1993, FLAMMABLE LIQUID, N.O.S. (contains 60% propylamine)".

¹³ IMDG Code, 2020 Edition Amendment 40-20, Section 2.0.2

¹⁴ IMDG Code, 2020 Edition Amendment 40-20, Sections 2.0.2 and 3.1.2

¹⁵ IMDG Code, 2020 Edition Amendment 40-20, Section 3.1.2.8

Class¹⁶

The Class is the hazard classification of a substance as determined by the UN Classification tests and is shown in Column 3 of the Dangerous Goods List. Use the numerical entry in Column 3 immediately after the Proper Shipping Name:

As it appears on shipper's declaration: "UN 2022, CRESYLIC ACID, Class 6.1".

See section B3 below on *Classification*.

Subsidiary hazard¹⁷

If a substance has more than one hazard characteristic this must be identified in the Dangerous Goods List. In such cases the main class is shown in Column 3 and in addition any subsidiary hazard class(es) shown in Column 4. Note that a maximum of two subsidiary hazards are only ever included.

If there is a subsidiary hazard class applicable this must be placed within brackets after the main class.

As it appears on shipper's declaration:

"UN 2901, BROMINE CHLORIDE, Class 2.3, (5.1/8)".

Packing group¹⁸

The Packing Group (PG) I, II or III indicates the degree of danger with PG I as the greatest danger and PG III as low danger. Not all UN Numbers have packing groups, but most of the entries in Classes 3, 4 (other than self-reactive substances), 5.1, 6.1, 8 and most in 9 have a packing group. These are indicated by I, II or III in Column 5 of the Dangerous Goods List. When entered on the transport document they may be preceded by 'PG' as in our example below.

As it appears on shipper's declaration:

"UN 2022, CRESYLIC ACID, Class 6.1, 8, PG II".

See section B6 below on *Packing Groups*.

Number and type of packages¹⁹

These are a simple description of the packages and must always be included except for empty, unclean packagings. e.g. 80 x Drums or 440 fibreboard boxes

The IMDG Code does not require the transport document to include the following in the description of the type of packaging:

- the material of which the packaging is made
- the packaging codes
- the number, type and capacity of each inner packaging

Note: Shipping lines may request some or all of these items as a cross check, and frequently require the packaging code (e.g. 4G for fibreboard boxes).

Net and gross mass of each type of dangerous goods in the consignment

The net mass is the weight of a dangerous substance without the packaging. If more than one substance is in the consignment, the net mass of each UN Number must be shown separately. The gross mass is combined weight of the dangerous goods and the packaging.

¹⁶ IMDG Code, 2020 Edition Amendment 40-20, Section 2.0.1.1

¹⁷ IMDG Code, 2020 Edition Amendment 40-20, Section 2.0.0

¹⁸ IMDG Code, 2020 Edition Amendment 40-20, Section 2.0.1.3

¹⁹ IMDG Code, 2020 Edition Amendment 40-20, Section 5.4.1.5.1

Typical declarations

Example 1

No. and type of packages: 80 x drums (+ volume or mass as appropriate)

UN Number: UN 2322

Details from the Dangerous Goods List:

Proper Shipping Name: TRICHLOROBUTENE

Class: 6.1

Sub-hazard: N/A

Packing group: PG II

Marine pollutant: Yes

IMDG Declaration of 80 drums as it would appear on the shipper's declaration:

80 x drums (volume or mass as appropriate)

UN 2322, TRICHLOROBUTENE, 6.1, PG II, MARINE POLLUTANT

Example 2

No. and type of packages: 500 x jerricans (+ volume or mass as appropriate)

Details from the Dangerous Goods List:

UN Number: UN 1098

Proper Shipping Name: ALLYL ALCOHOL

Class: 6.1

Sub-hazard: 3

Packing group: PG 1

Flashpoint: (+21°C c.c.).

Marine pollutant: Yes

IMDG Declaration of 500 jerricans as it would appear on the shipper's declaration:

500 x jerricans (+ volume or mass as appropriate)

UN 1098, ALLYL ALCOHOL, 6.1, (3), PG I (+21°C c.c.) MARINE POLLUTANT

Example 3

No. and type of packages: 100 fibreboard boxes (+ net and gross mass)

Details from the Dangerous Goods List:

UN Number: UN 1993

Proper Shipping Name: FLAMMABLE LIQUID, N.O.S.
(Ethanol and Dodecylphenol)

Class: 3

Packing Group: II

Flashpoint: (18°C c.c.)

Marine pollutant: Yes

IMDG Declaration for 100 fibreboard boxes as it would appear on the shipper's declaration:

100 x fibreboard boxes (+ volume or mass as appropriate)

UN 1993, FLAMMABLE LIQUID N.O.S. (Ethanol and Dodecylphenol), 3, PG II (18°C c.c.) Marine Pollutant.

A4.3 Variable cargo details

This section lists a variable range of common and less common cargo details that the shipper may be required to provide.

In addition to the details listed in the previous section, the shipping line may require supplementary mandatory information from the IMDG Code that will vary depending on the nature and classification of the dangerous goods.

Most of this information can be obtained in the Dangerous Goods List of the IMDG Code, but some has to be obtained from within the text of the Code or from the shipper's classification in the case of N.O.S. substances. Shippers and freight forwarders that do not have a good working knowledge of the IMDG Code, should always be encouraged to seek advice from experts in the dangerous goods department of the shipping line regarding documentation requirements, but shipping lines will not make decisions on classification – that must come from the shipper.

While shipping lines will try to be helpful when taking bookings, it must be understood that it is the shipper's legal duty to present accurate and full descriptions of dangerous cargoes offered, and the assistance that shipping lines can provide is legally limited.

Consequentially, incorrectly documented or badly packed cargo will be rejected at booking stage or shut out even if the booking has been accepted in principle, and delays and unplanned cost overheads will be incurred for remedial work.

The following are variable cargo details that the IMDG Code may require to be included in the shipper's declaration, depending on the type of cargo offered.

Flashpoint²⁰ for Class 3 substances and substances with a subsidiary Class 3 hazard

Class 3 substances are liquids that that give off a flammable vapour at temperatures at or below 60°C. For single entries for well-defined substances the flashpoint is provided in the properties and observation column of the DGL, however, due to the presence of impurities, the actual flashpoint may be lower or higher than this reference temperature.

The flashpoint must be included in the shipper's declaration for a flammable liquid and be added after the Packing Group in brackets according to shipper's determination.

This also applies to substances with a subsidiary hazard of Class 3.

As it appears on shipper's declaration:

"UN 1090, ACETONE, 3, PG II, (-20°C c.c.)"

Marine pollutant²¹

Marine pollutants are substances or articles that are hazardous for the marine environment. Any class of dangerous goods substance (apart from class 7) can also be a marine pollutant, but not all of them are. Also, substances that are not otherwise classified as dangerous goods may fit the criteria for classification as marine pollutants and are classified as "Environmentally Hazardous Substances, Solid/Liquid, N.O.S., Class 9".

When goods are marine pollutants the words "MARINE POLLUTANT" are added at the end of the description of the dangerous goods.

As it appears on shipper's declaration:

"UN 2826, ETHYL CHLOROTHIOFORMATE, Class 8 (3), PG II, (29°C), MARINE POLLUTANT"

²⁰ IMDG Code, 2020 Edition Amendment 40-20, Section 5.4.1.4.3.6

²¹ IMDG Code, 2020 Edition Amendment 40-20, Section 5.4.1.4.3.5

Solid or liquid

The UN classification system differentiates between solid and liquid states of the same product, as the hazards are different. Where the words "SOLID" or "LIQUID" appear in the Proper Shipping Name in Column 2 of the Dangerous Goods List it must be included in the declaration.

As it appears on shipper's declaration:

"UN 3429, CHLOROTOLUIDINES, LIQUID, 6.1, PG III,
UN 2239, CHLOROTOLUIDINES, SOLID, 6.1, PG III"

Polymerizing substances²²

These are substances that, at 50°C or less, without chemical or temperature stabilization, are liable to undergo a strongly exothermic reaction resulting in the formation of larger molecules or polymers, evolving heat and gas.

The person offering the substance for transport must ensure that it will not polymerize at temperatures liable to be encountered during transport, and must take measures to stabilize the product, either by chemical or thermal stabilization.

When stabilization is by thermal control, the shipper's declaration for polymerizing substances must include the Control Temperature and Emergency Temperature²³.

Stabilized substances²⁴

When substances would be forbidden for transport because they are unstable and liable to react dangerously or polymerize at temperatures encountered during transport, they may be chemically or thermally stabilized, or both.

When substances are thermally stabilized for transport, the word "STABILIZED" becomes part of the Proper Shipping name.

If the substance is thermally stabilized the shipper's declaration must include the Control Temperature and Emergency Temperature.

Control temperature and emergency temperature²⁵

This is required to be shown on documentation for dangerous substances that have a Self-Accelerating Decomposition Temperature (SADT) that may be encountered in transport and that must be carried below a specific temperature under controlled temperature conditions.

As it appears on shipper's declaration: "CONTROL TEMPERATURE +20° C" and "EMERGENCY TEMPERATURE +30°C".

Empty uncleaned packages²⁶

Including drums, gas cylinders, large packagings, intermediate bulk containers, (IBCs), bulk containers, tanks (all kinds) and tank containers, containing dangerous goods residue.

Nominally empty uncleaned packages that contain residue of dangerous goods are still dangerous to handle, can give off dangerous vapours, and may explode in fires. Such items must be declared, documented, marked and labelled with Proper Shipping Name, UN Number and class, sub-hazard, flashpoint etc, as for any normal dangerous goods with an additional clause on the declaration to indicate the package is nominally empty.

As it appears on shipper's declaration: "EMPTY UNCLEANED" or "RESIDUE LAST CONTAINED" should appear before or after the Proper Shipping Name.

²² See Section B9 below on Special controls for polymerizing and unstable substances stabilized for transport

²³ IMDG Code, 2020 Edition Amendment 40-20, Section 7.3.7

²⁴ IMDG Code, 2020 Edition Amendment 40-20, Section 5.4.1.5.4

²⁵ IMDG Code, 2020 Edition Amendment 40-20, Section 5.4.1.5.5 and see Section B9 below for further details on Control and Emergency temperatures

²⁶ IMDG Code, 2020 Edition Amendment 40-20, Section 5.4.1.4.3.2

Wastes²⁷

Dangerous goods transported as wastes for recycling or disposal must be declared to the shipping line and on the shipper's declaration. This is a requirement of the IMDG Code, but it is likely to also be a requirement of local legislation, such as the EC Transfrontier Shipment of Waste Regulations, and may be subject to local port regulations.

As it appears on shipper's declaration: The word "WASTE" should appear before the Proper Shipping Name.

Note: Many shipping lines are unwilling to carry wastes because they can be vicariously liable for charges if wastes are mis-declared.

Salvage packagings including large salvage packagings and salvage pressure receptacles²⁸

Cargo shipped in salvage packaging including large salvage packagings and salvage pressure receptacles, for whatever reason, must be notified to the shipping line. The salvage packaging used must conform to United Nations test standards for PG II.

As it appears on shipper's declaration: The words "SALVAGE PACKAGE" or "SALVAGE PRESSURE RECEPTACLE" should be added to the document together with the number of salvage packages and an estimate of the quantity (kg or litres) of dangerous goods in the salvage package(s).

Radioactive materials²⁹

Many shipping lines do not carry radioactive materials because of the difficulty in placing insurance and because many ports do not permit the transit of radioactive materials.

Owing to complexity of radioactive materials there is a great deal of information and certification related to the product and its packaging, as well as safety instructions and emergency procedures that could be justifiably requested by the shipping line. As each shipping line will come to its own considered opinion about the carriage of radioactive materials and the controls it wishes to apply, this section will not go into the details that could be requested. The statutory documentation details are set out in the IMDG Code.

Explosives³⁰

Like radioactive materials there are insurance and port transit difficulties shipping explosives. To consider accepting explosives, the shipping line will need to know the hazard division and compatibility group of the explosives as these will determine the shipboard segregation, port restrictions, and insurance limits of the potential cargo. Many ports accept no explosives except Class 1.4S, the least restrictive.

The quantity of explosives is measured in net explosive quantity (NEQ) – also referred to as the Net Explosives Content (NEC) which is the amount of explosives compound in the article consignment. The gross weight of ancillary equipment incorporated in or around the explosives is unimportant – only the NEQ matters for the calculation of port limits and shipboard segregation.

As it appears on shipper's declaration: A typical description of an explosives consignment would be as follows:

**20 x boxes, UN 0012, CARTRIDGES, SMALL ARMS, Class 1.4S,
Net explosive quantity (NEQ) 15 kilograms
Net weight 550 kilograms
Gross weight 600 kilograms**

²⁷ IMDG Code, 2020 Edition Amendment 40-20, Sections 2.0.5 and 5.4.1.4.3.3

²⁸ IMDG Code, 2020 Edition Amendment 40-20, Section 5.4.1.5.3

²⁹ IMDG Code, 2020 Edition Amendment 40-20, Section 5.4.1.5.7

³⁰ IMDG Code, 2020 Edition Amendment 40-20, Section 5.4.1.5.9

Carriage at elevated temperature³¹

Liquids carried in tanks at 100°C or more and solids carried at 240°C or more must be declared, even if the substance is not classed as dangerous goods at normal temperatures.

As it appears on shipper's declaration: The words "MOLTEN" or "ELEVATED TEMPERATURE" may appear as part of the Proper Shipping Name, but if this is not the case, the word "HOT" should precede the Proper Shipping Name on the document.

Fumigated cargo transport units³²

Many cargo transport units carrying non-hazardous cargoes particularly unprocessed food products such as beans and rice, and some carrying dangerous goods cargoes are fumigated in transit for pest control reasons.

The method is by the introduction of highly toxic penetrative gas, usually a derivative of phosphine. All methods create a hazard when fumigated units are stowed in confined spaces below deck on ships, and a severe hazard for any person who may be required to enter the cargo transport unit before it has been ventilated to clear the gas.

A container shipped under fumigation becomes a dangerous goods movement, regardless of the cargo, and must be declared, documented and manifested as dangerous goods.

As it appears on shipper's declaration:

"UN 3359, FUMIGATED CARGO TRANSPORT UNIT, CLASS 9"

This description should be followed in the document or accompanied by a fumigation certificate with the following information:

- The date and time of fumigation
- The type of fumigant
- The amount of fumigant used

The documents shall include instructions for disposal of any residual fumigant or fumigation device.

Emergency telephone numbers

There is no requirement in the IMDG Code for the shipper to provide his telephone number to assist in an emergency. However, shippers may provide them, even though it may not be a 24/7 number.

Note, some countries including USA have legislation requiring a 24-hour emergency number to be provided so it is always worth checking if this is required.

As it appears on shipper's declaration: The telephone number should be entered on shipper's declaration in such a way that it cannot be confused with any part of the cargo description.

³¹ IMDG Code, 2020 Edition Amendment 40-20, Section 5.4.1.4.3.4

³² IMDG Code, 2020 Edition Amendment 40-20, Section 5.5.2

A4.4 The dangerous goods transport document

While the previous sections dealt with the details that shippers may be required to provide when making a dangerous goods booking, this section looks at how those details should be entered on the dangerous goods transport document, the formal document that must accompany the consignment.

The transport document can be in any format but must contain the declaration details of the dangerous goods, the wording of the shipper's declaration and the wording of the packing certificate from the UN model in IMDG Chapter 5.4. The packing certificate may be on a separate document to the shipper's declaration, but is most commonly on a version of the UN combined form shown below. This form is multimodal and can be used for all surface modes.

Note that the use of electronic data processing (EDP) and electronic data interchange (EDI) transmission techniques is permitted as an alternative to submission of paper documentation.

Example of the multimodal dangerous goods form – see IMDG Code 5.4.5

1 Shipper/Consignor/Sender		2 Transport document number		
		Page of pages	4 Shipper's reference	
		5 Freight forwarder's reference		
6 Consignee		7 Carrier (to be completed by the carrier)		
		SHIPPER'S DECLARATION I hereby declare that the contents of this consignment are fully and accurately described below by the Proper Shipping Name, and are classified, packaged, marked and labelled/packaged and are in all respects in proper condition for transport according to the applicable international and national governmental regulations.		
8 This shipment is within the limitations prescribed for:		9 Additional handling information		
CARGO ONLY				
10 Vessel/flight No. and date	11 Port/place of loading			
12 Port/place of discharge	13 Destination			
14 Shipping marks	Number and kind of packages; description of goods*	Gross mass (kg)	Net Mass (kg)	Cube (m ³)
Processed on Hazcheck Online using IMDG Code Amendment 40-20				
15 Container identification No./ vehicle registration No.	16 Seal number(s)	17 Container/vehicle size and type	18 Tare mass (kg)	19 Total gross (incl. tare) (kg)
CONTAINER/VEHICLE PACKING CERTIFICATE I hereby declare that the goods described above have been packed/loaded into the container/vehicle identified above in accordance with the applicable provisions.** MUST BE COMPLETED AND SIGNED FOR ALL CONTAINER/VEHICLE LOADS BY PERSON RESPONSIBLE FOR PACKING/LOADING		21 RECEIVING ORGANIZATION RECEIPT Received the above number of packages/containers/vehicles in apparent good order and condition, unless stated hereon. RECEIVING ORGANIZATION REMARKS:		
20 Name of company		Hauler's name	22 Name of company (OF SHIPPER PREPARING THIS NOTE)	
Name/status of declarant		Vehicle reg. no.	Name/status of declarant	
Place and date		Signature and date	Place and date	
Signature of declarant		DRIVER'S SIGNATURE	Signature of declarant	

As well as information pertaining to the dangers presented, the name and address of the consignor and the consignee of the dangerous goods must be included on the transport document along with the date when the document or an electronic copy of it was prepared or given to the initial carrier.

Certification of the dangerous goods transport document³³

Once all details have been completed on the dangerous goods transport document it must include a declaration or certification, signed and dated by the consignor, stating that the consignment is acceptable for transport and that the goods are properly packaged, marked and labelled and in proper condition for transport by sea.

Further information on the consignor's/shipper's declaration, including an example of a completed dangerous goods transport document, may be found at Section A7.2 and A7.3 of this guide.

If EDP or EDI is used to transmit the document, the signature(s) may be electronic signature(s) or may be replaced by the name(s) in capitals of the person authorised to sign.

Container/vehicle packing certificate³⁴

When dangerous goods shipped by sea are packed into a container, vehicle or trailer, those responsible for the packing operation must provide a 'container/vehicle packing certificate' specifying the container/vehicle identification number(s) and certifying that the operation has been carried out in accordance with the conditions listed in IMDG 5.4.2.1.

As mentioned above, the information required on the transport document and the container/vehicle packing certificate may be incorporated into a single document, otherwise they must be attached to each other.

See Step 7 for further information on the packing certificate.

A4.5 Additional certification³⁵

In addition to the shipper's declaration on the transport document (dangerous goods document/dangerous goods form) some consignments will require additional certification to be given to the line. Some examples are below:

- Weathering certificate
- Exemption certificate
- Letter of indemnity
- Competent Authority Approval

³³ IMDG Code, 2020 Edition Amendment 40-20, Section 5.4.1.6

³⁴ IMDG Code, 2020 Edition Amendment 40-20, Section 5.4.2

³⁵ IMDG Code, 2020 Edition Amendment 40-20, Section 5.4.4 and Chapter 7.9.2

Step 5: IMDG segregation

A5 Segregation of incompatible dangerous goods

IMDG Part 7 predominantly looks at stowage and segregation of dangerous goods both within a CTU and between CTUs onboard a ship.

Here though we focus on segregation within in a CTU as this is one of the major considerations when packing containers.

A5.1 Introduction

Segregation in the context of the IMDG Code is the process of separating two or more dangerous substances or articles which are considered mutually incompatible when their packing or stowage together may result in undue hazards in case of leakage or spillage, or any other accident.

Segregation can be considered in terms of:

- between packages on deck, within the hold of a ship or loaded inside a CTU;
- between packages and CTUs; or
- between CTUs.

As far as cargo packers are concerned, this means not packing incompatible dangerous goods in the same cargo transport unit; for ship stowage planners it means stowing cargo transport units containing incompatible dangerous goods in different parts of the ship to prevent a dangerous reaction between the contents of the different CTUs.

There are instructions in IMDG Chapter 7.2 for calculating the rules for determining which dangerous goods are prohibited in the same shipping container and which may be packed together.

In the following sections we focus on segregation within a CTU and the process the packer must follow when packing different dangerous goods into the same CTU.

A5.2 Segregation checks when preparing a mixed load dangerous shipment for transport

There are two key points at which a segregation check must be carried out. The first should be carried out by the shipper before offering a multiple hazard cargo, and then when a packer is preparing to pack multiple hazard cargoes into a single cargo transport unit.

A shipper offering different types of dangerous goods in the same consignment needs to determine if the goods can be packed in the same cargo transport unit. However, if the shipper sends his dangerous goods to a consolidator he has no control over what is packed into the cargo transport unit. It is always the party who is in charge of packing the unit who must carry out the definitive segregation check.

Packers consolidating dangerous goods of different types into a cargo transport unit for several different shippers need to carry out a segregation check between each of the proposed dangerous goods items before packing commences as it is their responsibility to sign the container packing certificate that attests, amongst other things, that the IMDG Code segregation requirements have been followed.

A5.3 Methods for checking the segregation

The only method of ensuring compliance is to follow the IMDG segregation rules although there are different options for doing this:

IMDG Code books

Train staff to consult the segregation rules in IMDG Chapter 7.2 and follow the rules manually. This requires a basic understanding of classification as well as knowledge of the segregation process. It can become complex when there is a high number of dangerous goods items being shipped together in the same cargo transport unit.

Online validation systems

The often complex nature of applying the IMDG Code segregation rules can be assisted via computer based or online validation tools. UN Numbers are fed into the program and an IMDG Code compliance/non-compliance report can be automatically generated.

Hazcheck Systems produced by Exis Technologies provide a number of solutions to assist with IMDG Code validation including complex segregation calculations. Further details can be found at www.hazcheck.com. The screenshot below is taken from Hazcheck Online and highlights the validation results for an incompatible dangerous goods load:

The screenshot shows the Hazcheck Online interface. At the top, there are navigation buttons: Main, Enquiry, Process the Load, Feedback, hazcheck.com, Help, Training, and Logoff. Below this is a progress bar with icons for a plus sign, a question mark, a checkmark, a document, and a gear. The main content area is titled "STEP 2 - Validation" and "Consignment in a CLOSED CTU and validated for a CARGO safety (Annex 40-20)".

(Item) UN No	Class/ Sub.hazards	PG	ADR Transport Category and Tunnel Code	Special Provisions	Name & Variation details	Segregation groups
(1) 1234	3	II	2 D/E	[IMDG] [ADR]	METHYLAL	
(2) 2248	8/3	II	2 D/E	[IMDG] [ADR]	DI-n-BUTYLAMINE	
(3) 1170	3	II	2 D/E	[IMDG] 144 [ADR] 144 601	ETHYL ALCOHOL - Packing group II.	
(4) 1748	5.1	II	2 E	[IMDG] 314 [ADR] 314	CALCIUM HYPOCHLORITE, DRY - Packing group II.	Hypochlorites [IMDG]
(5) 2267	6.1/8	II	2 D/E	[IMDG] [ADR]	DIMETHYL THIOPHOSPHORYL CHLORIDE	Acids [IMDG]
(6) 2318	4.2	II	2 D/E	[IMDG] [ADR] 504	SODIUM HYDROSULPHIDE	Alkalis [IMDG]

Below the table is a section titled "Segregation Check Results". It contains the following text:

Load does not comply.
Segregation is required between pairs of substances listed below.

Substance	Conflicts with	Substance
(1) 1234	Separated from	(4) 1748
(2) 2248	Separated from	(4) 1748
(3) 1170	Separated from	(4) 1748
(2) 2248	Separated from	(5) 2267
(4) 1748	Separated from	(5) 2267
(1) 1234	Separated from	(6) 2318
(2) 2248	Separated from	(6) 2318
(3) 1170	Separated from	(6) 2318
(4) 1748	Separated from	(6) 2318
(5) 2267	Separated from	(6) 2318

At the bottom of the results section, it says: "Go back to [Add Items](#) to exclude the conflicting substances".

Computerised systems like this are useful in calculating segregation, but users are required to be familiar with the software as well as understand the IMDG Code segregation process.

Software embedded in the shipping line booking system

Shipping lines frequently have IMDG Code software embedded into their booking systems to assist in identifying segregation errors at the booking stage. This allows errors to be quickly picked up before the shipment enters the transport stage.

A5.4 The IMDG Code segregation check process

The following outlines the main considerations when checking segregation for a mixed load of dangerous goods items.

Identify and gather all the dangerous goods details

To carry out a segregation check you will need to gather the UN Numbers, the classes, sub-hazards, and packing groups of the dangerous goods to be packed, and for N.O.S. whether or not they have a segregation group applied.

Check the segregation requirements between classes and sub-hazards

First check the compatibility between the classes of dangerous goods. Some classes are incompatible with others, and must never be packed in the same shipping container.

If a substance has a sub-hazard, that must also be checked for segregation restrictions against other classes and other sub-hazards in the same way as the main hazard class. In order to do this table 7.2.4 of the IMDG Code, shown below, must be used.

Class	1.1	1.2	1.5	1.1 1.2 1.5	1.3	1.4	2.1	2.2	2.3	3	4.1	4.2	4.3	5.1	5.2	6.1	6.2	7	8	9
Explosives	1.1	1.2	1.5	*	*	*	4	2	2	4	4	4	4	4	4	2	4	2	4	X
Explosives		1.3	1.6	*	*	*	4	2	2	4	3	3	4	4	4	2	4	2	2	X
Explosives			1.4	*	*	*	2	1	1	2	2	2	2	2	2	X	4	2	2	X
Flammable gases			2.1	4	4	2	X	X	X	2	1	2	2	2	2	X	4	2	1	X
Non-toxic, non-flammable gases			2.2	2	2	1	X	X	X	1	X	1	X	X	1	X	2	1	X	X
Toxic gases			2.3	2	2	1	X	X	X	2	X	2	X	X	2	X	2	1	X	X
Flammable liquids			3	4	4	2	2	1	2	X	X	2	2	2	2	X	3	2	X	X
Flammable solids (including self-reactive substances and solid desensitized explosives)			4.1	4	3	2	1	X	X	X	X	1	X	1	2	X	3	2	1	X
Substance liable to spontaneous combustion			4.2	4	3	2	2	1	2	2	1	X	1	2	2	1	3	2	1	X
Substances which, in contact with water, emit flammable gases			4.3	4	4	2	2	X	X	2	X	1	X	2	2	X	2	2	1	X
Oxidizing substances (agents)			5.1	4	4	2	2	X	X	2	1	2	2	X	2	1	3	1	2	X
Organic peroxides			5.2	4	4	2	2	1	2	2	2	2	2	2	X	1	3	2	2	X
Toxic substances			6.1	2	2	X	X	X	X	X	X	1	X	1	1	X	1	X	X	X
Infectious substances			6.2	4	4	4	4	2	2	3	3	3	2	3	3	1	X	3	3	X
Radioactive material			7	2	2	2	2	1	1	2	2	2	2	1	2	X	3	X	2	X
Corrosive substances			8	4	2	2	1	X	X	X	1	1	1	2	2	X	3	2	X	X
Miscellaneous dangerous substances and articles			9	X	X	X	X	X	X	X	X	X	X	X	X	X	X	X	X	X

The numbers and symbols in the table have the following meanings:

- 1 – “away from”
- 2 – “separated from”
- 3 – “separated by a complete compartment or hold from”
- 4 – “separated longitudinally by an intervening complete compartment or hold from”
- X – the Dangerous Goods List has to be consulted to verify whether there are specific segregation provisions
- * – see 7.2.7.1 of this chapter for the segregation provisions between Class 1 substances or articles

Let's look at an example of how this is applied and see if a Class 3 substance can be shipped together with a Class 4.1 substance. Using table 7.2.4 we see the following:

Class			1.1 1.2 1.5	1.3 1.6	1.4	2.1	2.2	2.3	3	4.1	4.2	4.3	5.1	(continued through the classes)
Explosives	1.1	1.2	1.5	*	*	*	4	2	2	4	4	4	4	4
Explosives		1.3	1.6	*	*	*	4	2	2	4	3	3	4	4
Explosives			1.4	*	*	*	2	1	1	2	2	2	2	2
2.1				4	4	2	x	x	x	2	1	2	2	2
2.2				2	2	1	x	x	x	1	x	1	x	x
2.3				2	2	1	x	x	x	2	x	2	x	x
3				4	4	2	2	1	2	x	x	2	1	2
4.1				4	3	2	1	x	x	x	x	1	x	1
4.2				4	3	2	2	1	2	2	1	x	1	2
4.3				4	4	2	2	x	x	1	x	1	x	2
5.1				4	4	2	2	x	x	2	1	2	2	x
5.2				4	4	2	2	1	2	2	2	2	2	2

(continued through the classes)

Since the two classes line up with an “x” in the crossover box this means that they are compatible at general class and sub-hazard level, and may be compatible to be packed in the same cargo transport unit.

If a 1, 2, 3, or 4 were displayed in the crossover box, this would mean that substances were not compatible and the segregation process stops there.

However, as the properties of individual substances and articles within each class may vary greatly, the Dangerous Goods List, column 16b, must also be consulted for particular provisions for segregation. Individual substances may be incompatible with a substance of another class, or incompatible with substances in the same class as itself.

IMPORTANT: The individual segregation requirements in column 16b of the dangerous goods list take precedence over the general class provisions.

Check for specific segregation requirements in column 16b of the dangerous goods list

As well as checking the generic class segregation requirements in 7.2.4 you must also check if there are any specific segregation requirements in column 16b. These segregation requirements will be referenced via either:

Segregation group code(s) as per 7.2.5; and/or

Segregation code(s) as per 7.2.8.

If there are no class segregation clashes found in 7.2.4 it is important to check that there are also no specific segregation clashes arising from these two additional requirements. An example of how these appear in the dangerous goods list is shown below:

Column 1 UN Number	Column 2 Proper Shipping Name	Column 3 Class	Column 16b Segregation
2714	ZINC RESINATE	4.1	SGG7
2716	1,4-BUTYNEEDIOL	6.1	SG35 SG36 SG55
2719	BARIUM BROMATE	5.1 (6.1)	SGG3 SG38 SG49

The meaning of these codes can be found in 7.2.5 (segregation group codes) and 7.2.8 (segregation codes). From our example above:

UN 2714 – SGG7 – Heavy metal compound

UN 2716 – SG35, SG36 and SG55 –

SG35 Stow "separated from" SGG1 – acids

SG36 Stow "separated from" SGG18 – alkalis

SG55 Stow "separated from" mercury salts

UN 2719 – SGG3, SG38 and SG49 –

SGG3 – Bromate

SG38 Stow "separated from" SGG2 – ammonium compounds

SG49 Stow "separated from" SGG6 – cyanides

But what does this means in terms of segregation?

For UN 2714 this means that presence of SGG7 identifies this as belonging to segregation group 7, heavy metal compounds. If this is stowed in a CTU with any other substance or article that requires segregating from heavy metal compounds then there would be clash and these items must be segregated i.e. not stowed in the same CTU.

For UN 2716, there are a number of additional segregation requirements to consider. If this substance is loaded in the same CTU as any other DG identified as being a 'acid', 'alkali' or 'mercury salt' then this substance must be separated from that DG.

For UN 2719, this substance is a member of segregation group 3, bromates so if it stowed in a CTU with any substance or article that must be segregated from bromates there would be a clash and the two items must not be stowed in the same CTU. In addition, this commodity must also be separated from 'ammonium compounds' and 'cyanides', so any DG loaded in the same CTU belonging to either of these two segregation groups must also not be stowed in the same CTU.

There are 18 segregation groups³⁶ in total, all of which are listed below (with the relevant code that appears in column 16b in brackets):

1. Acids (SGG1 or SGG1a)
2. Ammonium compounds (SGG2)
3. Bromates (SGG3)
4. Chlorates (SGG4)
5. Chlorites (SGG5)
6. Cyanides (SGG6)
7. Heavy metals and their salts (SGG7)
8. Hypochlorites (SGG8)
9. Lead and its compounds (SGG9)

³⁶ IMDG Code, 2020 Edition Amendment 40-20, Section 3.1.4.4 and 7.2.5

10. Liquid halogenated hydrocarbons (SGG10)
11. Mercury and mercury compounds (SGG11)
12. Nitrites and their mixtures (SGG12)
13. Perchlorates (SGG13)
14. Permanganates (SGG14)
15. Powdered metals (SGG15)
16. Peroxides (SGG16)
17. Azides (SGG17)
18. Alkalis (SGG18)

There are 78 segregation codes³⁷, an example of some of these is supplied below:

Segregation code	Description
SG6	Segregation as for class 5.1.
SG9	Stow "away from" class 4.3.
SG14	Stow "separated from" class 1 except for division 1.4S.
SG24	Stow "away from" SGG17 – azides.
SG26	In addition: from goods of classes 2.1 and 3 when stowed on deck of a containership a minimum distance of two container spaces athwartship shall be maintained, when stowed on ro-ro ships a distance of 6m athwartship shall be maintained.
SG34	When containing ammonium compounds, "separated from" SGG4 – chlorates or SGG13 – perchlorates and explosives containing chlorates or perchlorates.
SG48	Stow "separated from" combustible material (particularly liquids).
SG59	Stow "separated from" SGG14 – permanganates.
SG68	If flashpoint 60°C c.c. or below, segregation as for class 3 but "away from" class 4.1.
SG78	Stow "separated longitudinally by an intervening complete compartment or hold from" division 1.1, 1.2, and 1.5.

A5.5 Segregation group allocation for N.O.S. substances

Segregation is more problematic for N.O.S. substances used for generic entries, mixtures, solutions and preparations. The technical names that comprise this N.O.S. shipment might properly belong to segregation groups. If an N.O.S. substance has significant components that are in a particular segregation group, it would be likely that the N.O.S. substance should be included in that segregation group for the purposes of segregation, and if so, the shipper should allocate a segregation group and mention it on his shipper's declaration on the transport document.

Example

UN 1760, CORROSIVE LIQUID, N.O.S. (Phosphoric acid, acetic acid), 8, PG III, IMDG Code segregation group 1 – Acids

³⁴ IMDG Code, 2018 Edition Amendment 39-18, Section 7.2.8

A5.6 Foodstuffs³⁸

There are instances where dangerous goods must be separated from foodstuffs. This affects dangerous goods having a primary or subsidiary hazard of classes 2.3, 6.1, 7 (with the exception of UN 2908, 2909, 2910 and 2911), 8 and dangerous goods for which it is referred to in segregation code SG29 or SG50 in column 16b of the DGL, stowed in a conventional way, must be "separated from" foodstuffs stowed in a conventional way.

If either dangerous goods or foodstuffs are in a closed CTU, the requirement reduces to "away from".

If both dangerous goods and foodstuffs are in different closed CTUs, no segregation requirements apply.

Dangerous goods of class 6.2 stowed in a conventional way must be "separated by a complete compartment or hold from" foodstuffs stowed in a conventional way. If either dangerous goods or foodstuffs are in a closed cargo transport unit, dangerous goods must be stowed "separated from" foodstuffs.

A5.7 Special segregation provisions and exemptions

There are a number of special segregation provisions and exemptions from the segregation requirements. These include:

- Exemptions from taking into account conflicting subsidiary hazards if the substances are proven not to react dangerously with each other³⁹
- Exemptions for chemically similar substances⁴⁰
- Exemptions for class 8 acids and alkalis meeting certain conditions⁴¹
- Exemptions for dangerous goods in 'limited quantities' or 'excepted quantities' provided they do not react dangerously with each other⁴²

³⁸ IMDG Code, 2020 Edition Amendment 40-20, Section 7.6.3.1

³⁹ IMDG Code, 2020 Edition Amendment 40-20, Section 7.2.6.1

⁴⁰ IMDG Code, 2020 Edition Amendment 40-20, Section 7.2.6.3

⁴¹ IMDG Code, 2020 Edition Amendment 40-20, Section 7.2.6.5

⁴² IMDG Code, 2020 Edition Amendment 40-20, Sections 3.4.4 and 3.5.8

Step 6: Packing the cargo transport unit⁴³

A6 Packing the cargo transport unit

The packer is legally responsible for ensuring the dangerous goods are correctly presented and the cargo transport unit safely packed. There are a number of pre-packing checks the packer should build into his procedures to ensure that everything is in order before packing commences.

These checks will identify problems in advance, and add to the safety of the consignment, and assist the cargo handlers who will physically lift and stow the cargo. There are suggested checklists included in the Appendix to this Guide.

A6.1 Pre-packing assessment

Before packing commences, the packages and documentation should be checked by a competent person and the following checks made:

- The transport documents containing the shipper's declaration(s) contain the full details
- The packages have been checked for marks and labels, especially packages made up into palletised unit loads
- The package marks and labels tally with the details on the transport document
- Confirm that segregation checks for mixed hazard goods have been successfully carried out
- Packages are checked for damage and any damaged packages are set aside
- The packages are assessed for size, weight and strength
- Any requirement for special handling equipment (e.g. drum clamps) is noted
- Any special factors of the packages or stow are noted
- Lashings, strops, air bags, pallets, timber and sheet material to support and brace the stow are available to the packers

A6.2 Creating a stow plan for the packers⁴⁴

With the information about the consignment complete, a competent person should create a stow plan and load list that can be given to the packers and handling equipment operators.

This should guide the packers so that packing takes account of the following key factors:

- The size and type of packages so that weight is distributed evenly throughout the shipping container
- That packages are stacked in a way that does not overstress any individual package
- That adequate securing and bracing of packages is done and gaps can be filled during packing using materials as necessary to ensure the packages do not move in transit
- The stow plan should indicate which packages are heavy and which are light, with the lighter packages stowed on top of the heavier.
- The stow plan should allocate cargo weight distribution (see diagrams below).

⁴³ Further guidance can be found in the CTU Code:
www.unece.org/trans/wp24/guidelinespackingctus/intro.html

⁴⁴ IMO/ILO/UNECE Code of Practice for Packing of Cargo Transport Units (CTU Code), Chapter 3.2, 8, 9.1, 9.2 and 9.3

The stow plan should allocate cargo weight distribution

Measure the packages to make sure they will fit into your container

Check the weights of packages – then make sure the weight is spread evenly across container floor

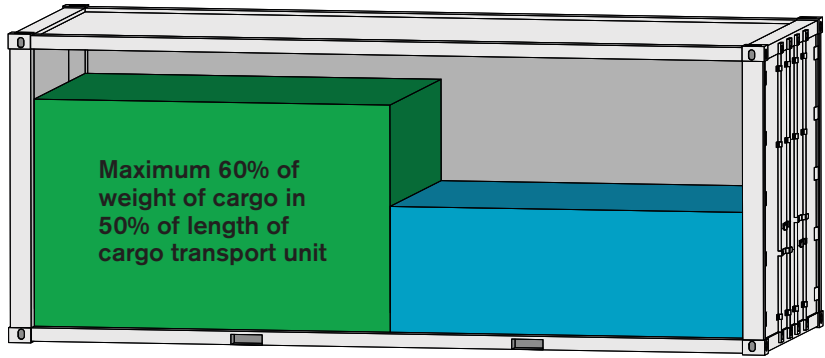

Weight spread evenly – container hangs level
– no lateral stress on cargo during lifting

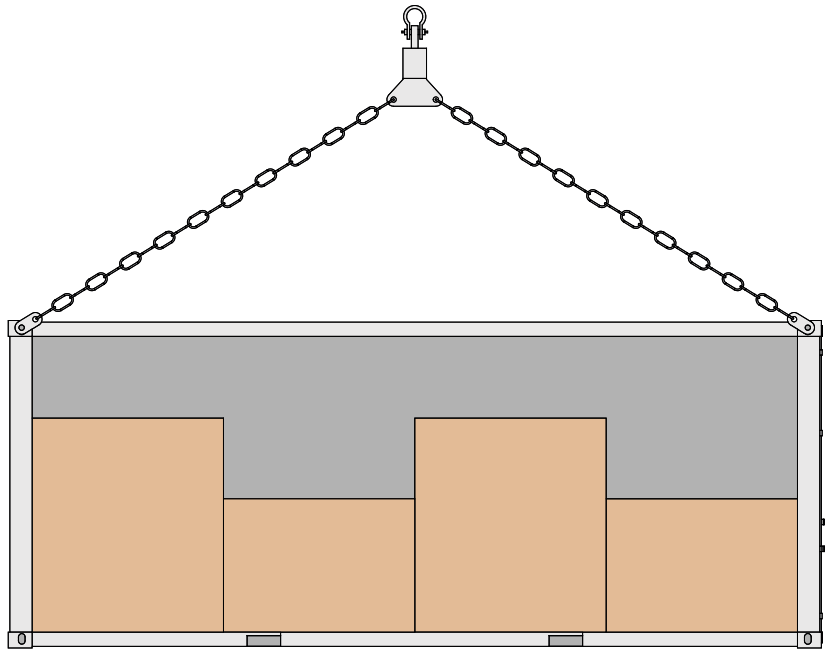

Weight at one end – container dangerously unbalanced

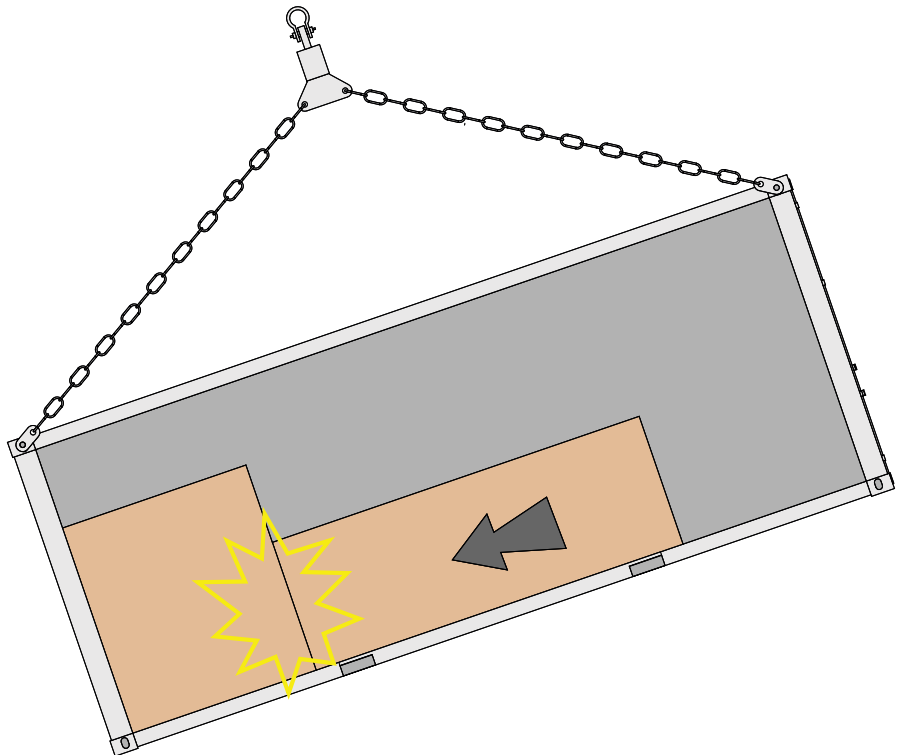

Lateral stress placed on cargo during lifting as container tips causes packages to shift resulting in a risk of crushing. Apart from the risk of packages being breached and allowing dangerous goods to escape, the lifting equipment may be damaged, or overbalance, adding physical injury and plant damage to the hazards of not balancing the stow.

A6.3 Checking the condition of the cargo transport unit⁴⁵

The cargo transport unit into which the cargo is packed becomes a “package” for the dangerous goods during the sea journey, so it must be checked to ensure that it is suitable for its job. The following section applies specifically to containers, but some aspects will also apply to vehicles loaded to ro-ro ships.

Before packing any cargo transport unit, the condition of the unit should be visually checked by a responsible person to determine the following

- Is it clean, dry and safe for packers to work in?
Ensure any marks and/or placards relating to previous shipments are removed.
- Is it suitable for dangerous goods?
- Is the container structurally sound?
- Is it within the legal safety inspection date?
- Is the plated capacity sufficient to carry the weight you intend to pack?
Check the maximum cargo weight marked on the right-hand door.

Reject any cargo transport unit that is damaged or unsuitable.

Residue

Residue or contamination on the floor may be a hazardous substance that will injure your employees or react with or spoil your cargo. Reject a contaminated container or clean it, having regard to potential injury to cleaners from an unknown substance.

Pest contamination

The CTU Code states “All persons involved in the movement of CTUs also have a duty to ensure, in accordance with their roles and responsibilities in the supply chain, that the CTU is not infested with plants, plant products, insects or other animals”⁴⁶.

Structural damage

Check visually for any indication of excessive corrosion, cracks or impact damage to main floor bearers or corner posts that may make the shipping container unsafe to lift.

Floor condition

Check that floor panels have not been damaged by overloaded forklift trucks.

Holes and leaks

Check for holes in the roof and sides – many packages will be susceptible to damage from rain or seawater, and some dangerous goods react violently on contact with water. Subject to safe working procedures, one method to detect holes is to stand inside the container and close the doors.

Nails in the floor

Check the floor for nails protruding from the floor, and remove them. Timber blocks and battens are often nailed to floors, and protruding nails are often left behind. These are a frequent cause of damage to pallets and packages, particularly drums packed direct to the container floor.

⁴⁵ IMO/ILO/UNECE Code of Practice for Packing of Cargo Transport Units (CTU Code), Chapters 4 & 8 and Annex 4

⁴⁶ https://www.iicl.org/iiclforms/assets/File/Pest_Contamination_Cleaning_Guidelines_Feb_2017.pdf

Old placards

Remove any redundant dangerous goods marks and placards from previous use – check both sides, and both ends – if they cannot be removed, ensure they are painted out.

Container data plate

Check the inspection information on data plate on the door.

Left: ACEP data plate – continuous inspection

Right: data plate with next due inspection date stamp



If the plate displays the letters “ACEP” it means the container operator subscribes to the Approved Continuous Examination Program and the container will meet the Container Safety Convention requirements for five yearly and 30 month examinations, and will normally also be inspected more frequently when the container passes through the operator’s depot. If there is no ACEP mark, the data plate is stamped with the next due date for inspection. If the date has expired, reject the container. However, do not rely only upon data plate date stamps – use visual inspection and common sense.

A6.4 Packing the cargo transport unit

The way the packages of dangerous goods are packed into a shipping container is the most important factor in making the transport safe. Poor packing leading to in-transit package damage, leaks and spills is the most common cause of damage to goods of all kind in cargo transport units. When dangerous goods are involved the potential consequences for ships are amplified. The following guidance is based on observation of numerous incidents. Follow the guidance and it will help you to avoid the most common problems.

Never pack damaged packages into a shipping container

It is an over-riding principle that damaged or leaking packages are not packed into a cargo transport unit. This applies to hazardous and non-hazardous materials. Despite this, it is not uncommon to find that leaking packages have been packed.

Packages are accidentally damaged from time to time during the handling as a result of human error, or use of unsuitable handling equipment. Individual cargo handlers may be reluctant to draw attention to the fact that they have caused damage for fear of repercussions, and companies may find it more convenient to conceal damaged packages in a freight container than to set them aside and accept the cost of clean-up, disposal, short-shipment or delays waiting for replacement packages. This is not acceptable.

Spillages of dangerous goods may react with the floor of the container, timber packaging/pallets or other cargo in a dangerous and unpredictable way. Spillages of non-hazardous goods may react with other cargo, spoil or taint other cargo, or damage other packages.

Pack dangerous goods closest to the door

If you are packing a cargo transport unit with a mixture of dangerous goods packages and non-hazardous packages, always put the dangerous goods packages closest to the door, if possible, with the labels also facing the door. In case of spillage or problem with the dangerous goods, it is preferable that they are packed next to the doors where the hazard class can be immediately identified when the emergency responders are able to access the contents of the container.

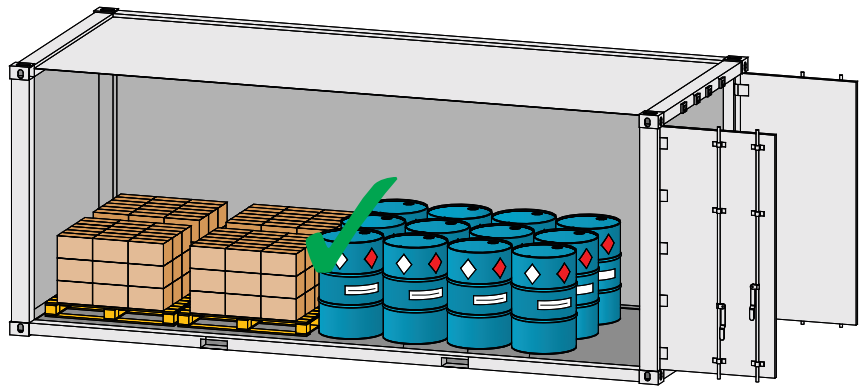
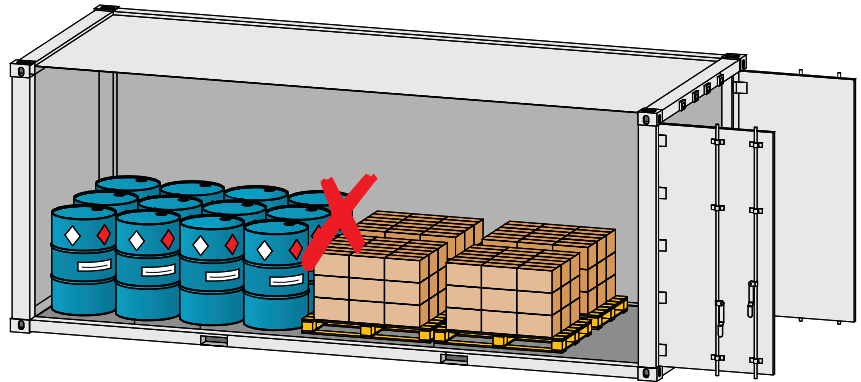

If the dangerous goods are stowed at the front of the shipping container, and there is a dangerous release from broken packages, the whole container will have to be unpacked by workers in protective equipment before the dangerous goods are reached. This makes emergency response much more difficult, lengthy, expensive and potentially dangerous.

Packages are only required to have labels on one side (two sides for IBCs) so as far as possible, packages should be stacked so that the labels are facing the door, where they can be seen by persons unpacking the shipping container or dealing with a problem.

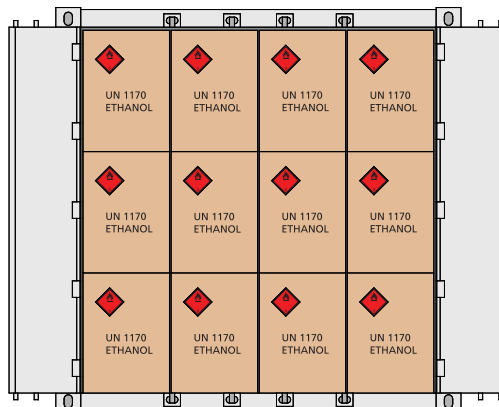

Packages stacked with dangerous goods labels facing the door

Pack solids over liquids

When drums of liquid have to be packed with packaged solid goods, never pack so that solids are over-packed by liquids. In general liquids are often heavier than solids, so it makes sense to pack with weight down, provided the drums are strong and can bear the weight. However, the main reason is for safety. If the drums leak, there will be a release of liquid that will first be drawn downwards by the force of gravity, and will then spread horizontally along the floor.

If the packages of solid goods are stowed on top of the drums, contact between the solid goods and the spilt liquid will be reduced. This reduces the risk of a dangerous reaction, and it is possible that no damage to the solid goods occurs at all.

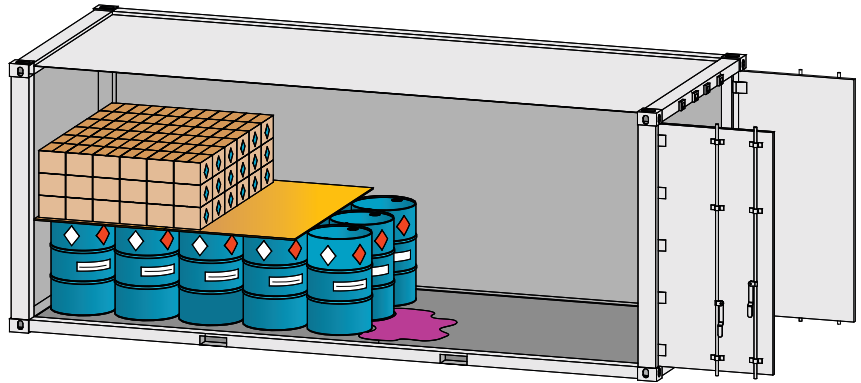

If solids are stowed on top of liquids, even if a drum becomes damaged and fails, there is a good chance that packages stowed above will remain unaffected.

Over-stowing cargo in shipping containers – Light over heavy

Over-stowing of one sort of cargo by another is proper and normal practice, when done with regard to the strength and weight of packages involved. However, there are many recorded incidents of packages of cargo in shipping containers being crushed because they were over-stowed by goods heavier than they could bear.



To pack a cargo transport unit safely takes skill and planning based on awareness of the strength and contents of the packages.

It may seem obvious that it is not a good idea to pack heavy machinery parts on top of fibreboard boxes containing fragile goods such as aerosols or glass bottles. To an experienced packer, it is a simple decision to pack the heavy cases first, and put the fibreboard boxes on top. However, an unskilled packer may not appreciate the weight difference and simply see an opportunity to build a flat platform of fibreboard boxes that are perfect on which to place the heavy machinery. The fibreboard boxes may survive the packing process but collapse once the cargo transport unit starts moving.

Inexperienced packers may mean no harm, but can do great damage to cargo without intention, simply because they do not understand the forces that will work on the shipping container at sea.

A6.5 Stacking capacity of packages – 20' versus 40' cargo transport unit

Packages are tested under the UN package certification system for stacking strength by stacking them and leaving them for a period of time in a motionless situation, although vibration test protocols are becoming available.

Stacking tests do not fully replicate the rigorous conditions inside a cargo transport unit in transit, where the packages are subjected to all kinds of motion and vibration. In reality, despite passing a static stacking test, the lower tiers of cargo may collapse under their own weight, as demonstrated in this photograph



Using sheet material between tiers is always recommended as a way of evenly distributing the weight. A more effective way is to use a 40' container in preference to a 20'.

Goods may physically fit within the cubic capacity of a 20' container, but that does not mean it will travel safely. If the cargo from a 20' container is placed in a 40' container the stack weight on the lower tier of packages will be halved. Although it will cost more to ship a 40' container, it may make the difference between a consignment arriving safely and intact, or damaged and unsaleable.

Stacking strength of packages is difficult to judge, and expensive errors are frequently made. If the shipper has chosen packages of doubtful robustness, the forwarder should make the shipper aware of the safer option of paying a little more for a 40' container.

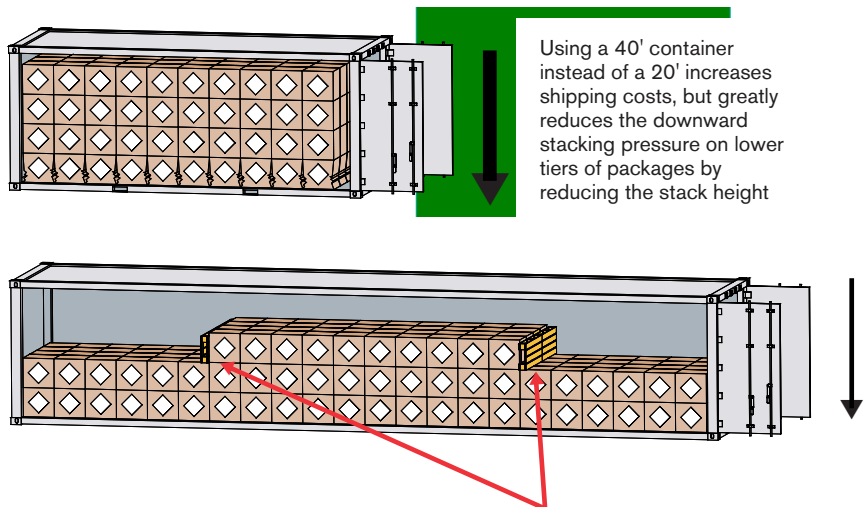

Because a 40' unit has been used, timber bracing will be needed to secure the packages from lateral movement in the upper tier because the upper tier does not reach from end to end of the shipping container

A6.6 Gap-stacking for air circulation

Some substances, particularly of Classes 4.1, 4.2 and 5.2, are sensitive to heat, or are liable to self-heat. Consignments of packages may need to be packed for transport such that air can circulate between individual packages. This helps to dissipate heat from local areas and prevent “hot spots” from developing deep inside the container. Reefer containers may be specified by the shipper to provide thermal control.

Shippers must provide clear guidance on packing if this system is required. Packages may be stacked directly into the container, or may be palletised. Gaps left between the packages should not be so large as to create “point loading” effect on the corners of the packages.

It may be desirable to use a 40' container in preference to a 20' to keep the stacks as low as practicable. This will enable the stack heights to be halved and the air space inside the shipping container to be maximised.

While clearly air circulation is an important consideration, it is critical that appropriate account is taken of the need to block, brace and secure cargo to protect it against the dynamic forces that will occur during transport.



High quality modern drums are resistant to damage, but are not indestructible

A6.7 Packing drummed cargo into cargo transport units

Steel and plastic drums of around 200 litre capacity are a common package choice for dangerous goods, but drums of up to 400 litres are acceptable for some products. A 20' container will comfortably take 80 x 200 litre steel or plastic drums and this is a common consignment. Drums are produced in a range of smaller sizes.

Strength and resistance of drums

Drums can be very robust, particularly plastic drums and steel drums with plastic liners, but both are vulnerable in certain areas. If drums that contain liquid are punctured, there is the obvious potential for a significant release of dangerous goods from a small hole.

Plastic and steel drums will withstand a fair amount of rough handling before the sidewalls rupture, and will deform extensively on impact before rupturing. Plastic drums will retain their original shape after a severe impact, but they are prone to blowing out their closures if subjected to sudden impact such as dropping. Also at very high temperatures and in strong direct sunlight the walls soften, giving them less resistance to cutting and a greater liability to lose rigidity if over-stowed heavily. Both materials are vulnerable to cutting if the sidewalls are struck with a sharp object.

If heavily over-stowed, plastic drums are liable to deform gradually, making the whole load unstable. Steel drums largely avoid this.

Handling drums on pallets

It is common to pack drums to a pallet as several can be handled in one lift, and no special drum-handling equipment is needed. However, forklift drivers need to be aware that steel drums puncture easily – they need to take care when working that the forklift arms do not protrude beyond the pallet being lifted, and stab the nearside drum on the pallet previously positioned. This is a common type of incident during packing, because it occurs outside the operator's range of vision.



Drums stabbed by forklift – a common cause of drum damage during handling

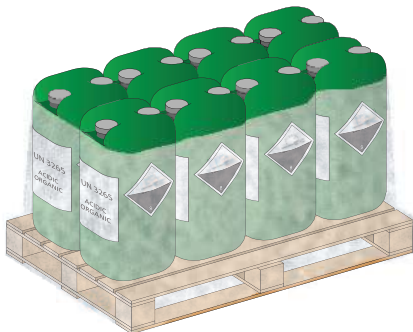

Drums on pallets should be wrapped with film or banded to keep them bound together as a unit

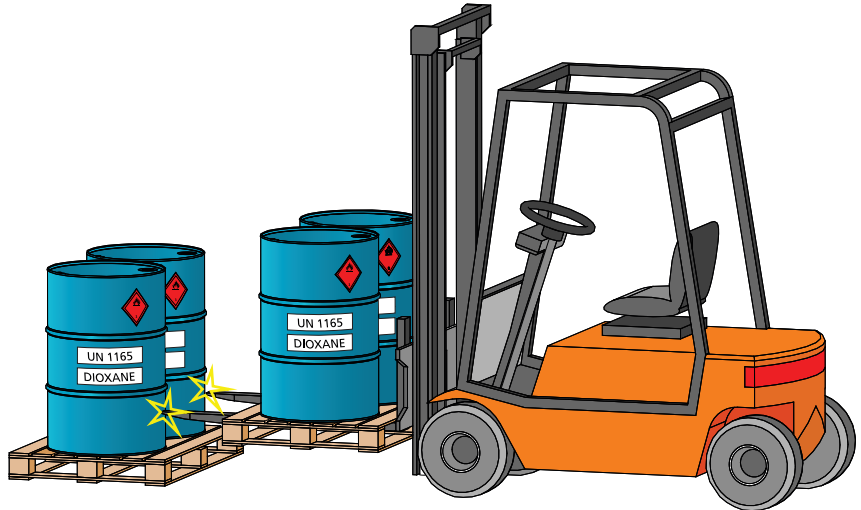

Punctured drums MUST be removed from the cargo transport unit

Drums leaking from damage received during packing are sometimes not removed from the container, causing problems later in the journey. If dangerous goods are involved, emergency procedures should be instigated by the forklift operator.

Recommended good practice for handling drums:

- Drums are easy to handle if the right handling equipment is provided.
- Loose drums are best handled using appropriate drum clamps attached to forklifts.
- Drums banded to pallets can be lifted four or more at a time, and can be packed using a conventional forklift.
- Palletised drums should be banded or film-wrapped tightly together, and banded to the pallet.
- Excessive manual rolling of full steel drums should be avoided, particularly over rough concrete, muddy ground, or ground containing small stones, as the drum seams or sidewalls can be damaged and stones can get embedded on the bottom of drums, and can cause punctures to the drums later in transport or during handling.



Drums being packed with drum clamps

Banding on pallets

Steel drums are also prone to sideways chafing if the rolling hoops align exactly during extended transit, particularly by rail, which can generate intense vibration.

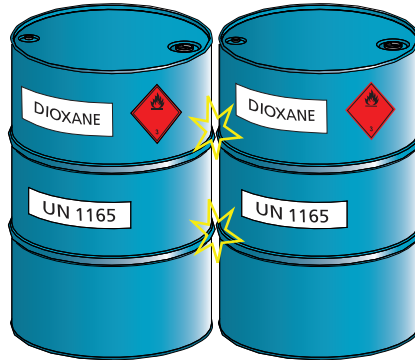

Rolling hoop chafing

Drums can be worn away in transit where the rolling hoops line up and are in contact for extended journeys

Recommended good practice for avoiding sideways chafing

In order to avoid edge to edge contact of the rolling hoops, particularly for long sea journeys, it is advisable to put plastic or heavy cardboard sections between drums bound together on pallets to prevent metal-to-metal abrasion.

Drums on the roll⁴⁷

It is forbidden to stow drums containing dangerous goods “on the roll”. Drums have closures at the top that are not designed to be below the liquid level.

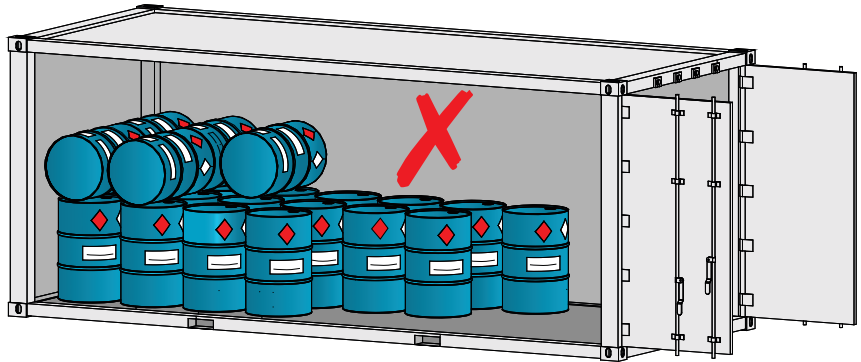

Drums containing dangerous goods shall always be stowed in an upright position unless otherwise authorised by the competent authority.

Using sheet timber spreader sheets between tiers of drums

Steel drums are designed to be stacked in tiers, and are often loose-packed into cargo transport units using drum clamp attachments.

However, steel on steel contact between the upper and lower drums during a sea voyage provides no resistance to movement, and the drums are liable to slide, causing the metal of the upper drum to be worn away on the lower rim seal, and drums to abrade against the container walls. This can lead to leakage from drums in the upper tier.

Placing sheet timber material between the layers of drums can easily prevent this sliding motion and reduces the build-up of pressure points motion where drums abrade against each other. Low-grade plywood is suitable, but chipboard is not recommended as it has less integral strength and degrades quickly in damp conditions.

Placing timber sheet between tiers of plastic drums also makes the stow more rigid and stable.

⁴⁷ IMDG Code, 2020 Edition Amendment 40-20, Section 7.3.3.4

A6.8 Packing dangerous goods on pallets

Stacking and wrapping packages to pallets to make unit loads is universal practice. However, some problems can arise from careless use of pallets, and pallets can be the indirect cause of serious releases of dangerous goods.

Point-loading – pressure damage to cargo overstowed by palletised goods

Palletised cargo stowed in upper and lower tiers inside cargo transport units can damage the cargo below, if the packages below are susceptible to pressure damage. This occurs if the weight of the palletised cargo is transferred to the goods below through the pallet's corner blocks, and is not spread evenly. The result is point-loading.



Point loading

Here, a pallet has damaged the drums below. The indent of the pallet above can be seen on the top of the drum in the corner. This could have been prevented by using a spreader sheet of plywood between the tiers of pallets

If the packaging of the goods on the lower tier is susceptible to point-loading damage, for example bags, plastic drums, paint pails, plastic and light steel jerricans (particularly the commonplace 5 litre light steel jerricans frequently used to retail dangerous goods), the packaging can collapse. This allows the product to escape and the pallet to further collapse.

If the surface of the cargo onto which the upper tier of pallets is packed is uneven, for instance bagged cargo, rounded plastic drums, or if the sizes of the packages on the lower tier is uneven, the pallet above may deform to the point of partial disintegration, causing further potential damage to cargo from protruding nails or split wood. The upper tier will become unstable if pallets break up, causing the cargo to shift inside the container, causing further cargo damage and further load instability.

Recommended good practice to avoid point-loading

The best protection is the provision of a layer of timber sheet material placed over cargo on lower tiers to spread the weight of over-stowed pallets evenly and prevent point loading. Low-grade plywood sheeting commonly used in the construction industry (shuttering board) to retain liquid concrete is suitable as it is robust, economical and widely available.

Common problems caused by pallet failure

Some pallets are robust and have strong lower bearers and flat load bearing upper panels made of solid boards. Heavyweight pallets are made for repeated use, are resistant to deformation, and can bear substantial loading without deformation or risk of disintegration. However, many pallets are designed for single use, and are constructed simply, economically and use low quality timber. Many are of extremely light and flimsy construction. This is acceptable provided the limits of the pallet are taken into account. Heavy cargo placed on to light grade pallets will deform or break the bearers.

The less robustly the pallet is constructed the more likely the pallet bearers will deform both under the weight of the cargo, and to the shape of the surface beneath. Even if the cargo is not damaged in transit, deformed pallets can make unpacking the goods by forklift very difficult, particularly when stowed with flexible IBCs. When pallets break up, it is often difficult to remove cargo from cargo transport units without causing further damage to the packages of cargo.



Lightweight pallets have been used for heavy cargo that has caused the pallets to break up and point packing has caused the plastic drums beneath to deform and collapse

It is common for a forklift operator to accidentally stab a package with the forks underneath the pallet while attempting to pack or unpack collapsed pallets. Flexible IBCs (usually 1-tonne woven polyester bags) damaged in this manner may release considerable amount of product and are difficult to handle manually. If fine powders such as carbon black are released, the recovery operation is dirty and contamination is difficult to contain.

If palletised boxes or 25 kg bags are involved, the pallet loads can be broken down manually and unit loads dismantled piece by piece. This adds greatly to the time and cost of handling, and defeats the objective of unitising the cargo in the first place. It also adds to the risk of individual packages being damaged during manual handling, and the time and cost of unpacking a container of dangerous goods in this way is considerable if workers need to wear breathing apparatus and protective clothing.

Recommended good practice to avoid collapse of pallets

It is best to select pallets strong enough to accept the mass to be borne by them. It may sound obvious but it is surprising how many times pallets are simply not strong enough to perform their function – to support the mass of the cargo during mechanical handling. It is accepted that in many situations there will not be a great choice of pallets, and perhaps only lightweight economy pallets are available.

However, such pallets can easily be strengthened by cutting timber sheet material (such as plywood) to the same size as the pallet, and placing it on top of the pallet before packing it, and between tiers if the pallets are being stacked one on the other. This will distribute the weight evenly and help to keep flimsy pallets intact by preventing the bearers from deforming.

Pallet inspection and selection

Many pallets are cheaply made from poor quality timber, and even well-made pallets will break up eventually if continuously re-used. It is common for nails to work out of the top boards and protrude upwards, presenting a risk of tearing bags or puncturing drums placed on the pallets. Such nails are not easy to see, so if old pallets are being re-used, the pallets should be checked carefully for split corner blocks and protruding nails.

Drums in particular present a problem. If placed on top of a protruding nail it is common for the bottom of the drum to be pierced, then temporarily sealed by the nail, so that the packers cannot observe the damage. The hole remains sealed until the container is moved. The nail hole is then gradually enlarged by the nail acting as a file, wearing away the metal or plastic of the drum until the hole is enlarged enough to release the product.

Use of second-hand or economy pallets can appear to be a money saver, but the ultimate cost in cargo damage, extra handling, spillage response costs and incidents caused by release of dangerous goods means that cheap pallets can be a false economy.

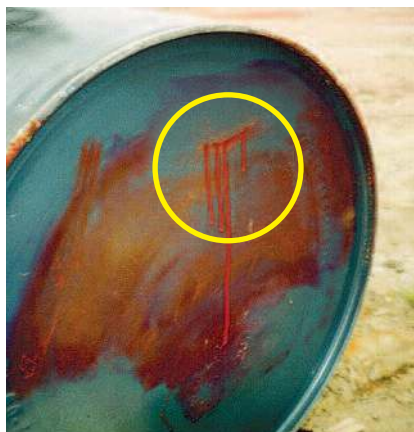

Typical nail-puncture damage
Red dye can be seen leaking from a hole made by a nail that was protruding from a broken pallet

Recommended good practice in choice and selection of pallets for dangerous goods

Before using any pallets, but particularly new economy pallets and second use pallets, they should be inspected for protruding nails and rejected or repaired. The use of timber sheeting cut to the size of the pallets will prevent nails from damaging the cargo, while adding to the strength of the pallet. However, low quality pallets are not recommended for use with dangerous goods.

A6.9 Solid frame Intermediate Bulk Containers (IBCs)

Solid frame IBCs are very common re-usable packages, a kind of small tank for liquids or powders designed for convenient mechanical handling. The most common size is around 1,000 litres in capacity and weighing around 1 tonne filled, but they may be up to 3,000 litres. A common design type is a semi-rigid plastic inner receptacle protected by a metal frame with a filler cap on the top and valve near the bottom, filled and discharged by gravity. While the frame is generally sturdy, the inner is vulnerable and not designed to withstand external pressure, point-loading or impact.

Left: Typical composite IBC (Intermediate Bulk Container) – inner plastic receptacle inside a rigid metal cage – not designed to be separated in use



Right: An IBC with the top of the inner receptacle broken by careless overstuffing



Stacking composite IBCs

Most composite IBCs are designed to be stacked, one on top of the other. If they are of the same design, this works well and they nest together securely. However, there is no standard design or size. Many instances have been investigated where IBCs of different shapes and profiles carrying liquids have been stacked two-high in containers, causing a variety of failures of the inner receptacles of the lower tier.

IBCs have data plates that record inspection dates and display symbols indicating the maximum stacking load,⁴⁸ as shown in the figures below:

Left: Symbol for IBCs capable of being stacked, with the maximum stack weight indicated

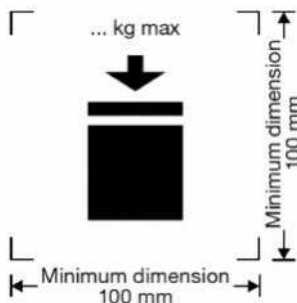

Right: Symbol for IBCs NOT capable of being stacked

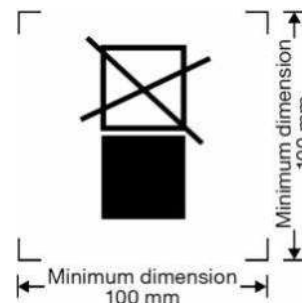

⁴⁸ IMDG Code, 2020 Edition Amendment 40-20, Section 6.5.2.2.2

Common causes of IBC failures in transport

The following problems can occur if stacked IBCs do not fit together or “nest” securely one on top of the other, or are carelessly over-stowed with other cargo:

Point loading punctures

If the upper IBC is slightly smaller than the lower, or is misaligned, one or more of the feet of the upper IBC can rest on the inner receptacle of the lower, eventually causing a puncture under pressure, forcing the contents of the lower IBC to be expelled. This leads to tilting of the upper IBC, causing further instability in the load.

Excessive downward pressure on an inner receptacle causes the closure to fail

If the upper IBC is smaller all round than the lower, it can sit inside the frame of the lower IBC, resting on the top of the inner receptacle. This will put excessive downward pressure upon the inner receptacle causing it to deform inwards, which can force the contents past the closure, or cause the closure to rupture, or cause the inner receptacle to fail catastrophically.

Damage during packing

If IBCs do not fit squarely together when stacked in the cargo transport unit because they are not the same size or shape, it is often difficult to use the forklift truck without causing damage to one or other of the units during packing and unpacking. Damage may be done to valves or the vulnerable inner receptacle, out of the line of vision of the forklift driver, perhaps without his knowledge.

Damage from overstowing

When one tier of IBCs is stacked inside a container it is tempting to use the flat tops of the IBCs as a load platform for other goods. IBCs are not designed to accept random overstuffing. Unless the overstuffing packages are very light in weight, it is easy to apply excessive downward pressure on the IBC, crushing the inner receptacle, again forcing product past the closure, causing rupture of the closure or catastrophic failure of the inner tank.



The inner plastic receptacle of this IBC has partly collapsed under the weight of a pallet that has broken through the top section of the IBC's protective metal frame

Good practice in the packing of IBCs

For the best results, IBCs of different design should not be mixed. If this cannot be avoided, the best solution is to board out on top of the lower tier of IBCs with wooden sheet material, cut to make a false floor. With this in place, the lower tier is protected and a tier of different shaped IBCs can safely be packed on top. With timber sheet material on top strengthened by timber planks or bearers, point loading is avoided, and a single tier of IBCs can safely withstand the weight of items placed on top of them as indicated by the stack weight symbol on the data plate.

A6.10 Securing the cargo inside the cargo transport unit⁴⁹

Unsecured packages are a major cause of damage to cargo. When non-hazardous cargo is damaged, the effect is expensive, time consuming, causes irritation to customers, and can cause cancellation of trade contracts. When the damage involves dangerous goods, it is all these things, plus it can create the conditions for a fire or explosion, catastrophic to a ship at sea, risking death and injury, and widespread cargo destruction, and disruption of the supply chain.



This cargo was insufficiently secured. Gaps were left into which cargo fell and as a result cargo was lost through breakage and contamination

Gap filling using pallets

The aim of securing cargo is to ensure it does not move within the shipping container. Movement results in damage to packages and consequent loss of cargo containment. In an ideal situation, cargo would fit neatly into containers with no gaps between packages of cargo, and no gaps between packages of cargo and the walls of the container. If there are gaps, the gaps must be filled.



Using pallets and timber to fill a gap and make a gate between the cargo and the doors



Using inflatable air bags to fill a gap between rows of pallets

Various methods can be used. A crude but effective method is to use pallets to fill gaps. They are freely available in most packing facilities, are light and easy to fit into place, and a convenient shape. Any smaller gaps between pallets can be filled out with planks of wood.

Pallets can be used in combination with heavy timber struts to produce effective walls to brace cargo. This is not an approved method, but it is a very common procedure, and if done carefully is effective.

Gap filling using air bags

A more sophisticated method of gap filling is to use inflatable airbags. These are more expensive and need air pumps to inflate the bags, but they are very effective. Care must be taken not to over-inflate bags in cold temperatures if the cargo is going to the tropics – as the air inside the bags will expand and could burst the bags.

⁴⁹ IMO/ILO/UNECE Code of Practice for Packing of Cargo Transport Units (CTU Code), Chapter 9.4 and Annex 7

Blocking and bracing

Often there is a large gap between the cargo and the container doors, and it is more practical to build a "gate" behind the cargo, and support that with timber bearers than it is to physically fill the gap.

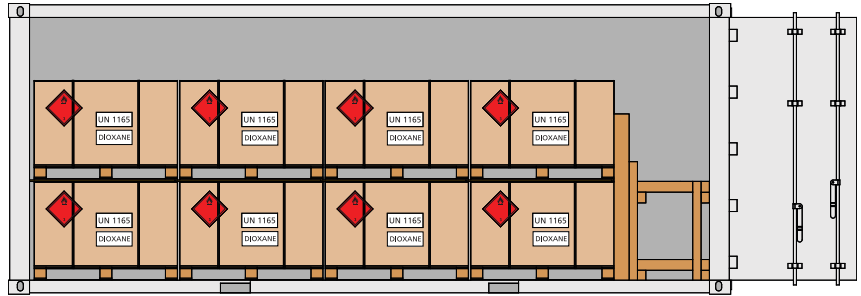

Timber "gate" to restrain cargo and bracing struts running back from gate to rear corner posts to support the gate restrains both upper and lower tiers of cargo.



Upright battens wedged against the container corner posts – (the strongest part of the container) take the strain

Timber cross-struts to hold back the cargo

The weight of the cargo is transferred to the corner posts by sturdy bearers nailed together

Blocking and bracing to achieve equal weight distribution

If individual packages of cargo are heavy, it is sometimes necessary to place cargo in the centre of the container to achieve reasonable weight distribution. This may require blocking and bracing at both ends of the top tier of cargo.

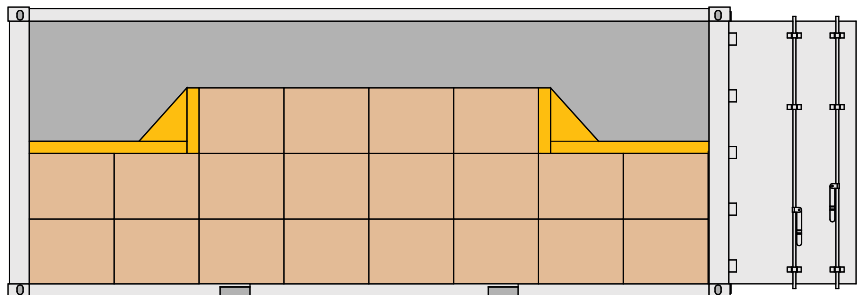

Blocking to prevent fore and aft movement of packages in the upper tier that does not reach from end to end of the shipping container

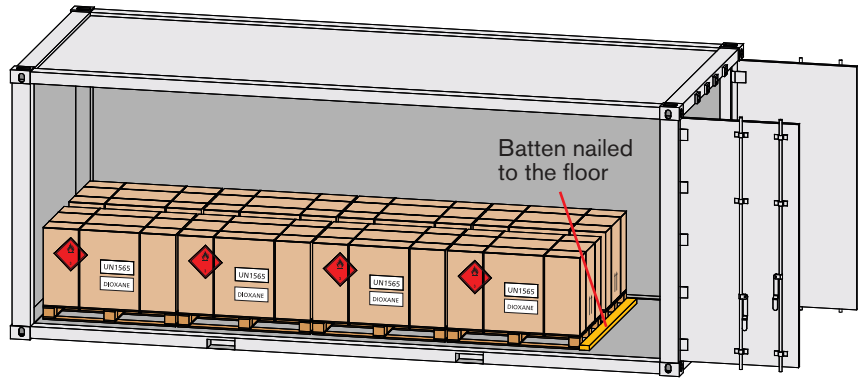

A sturdy timber batten 100mm x 150mm nailed to the floor of the shipping container is an effective way of resisting fore and aft movement for low profile packages if they are securely banded to pallets



Container lashing points

A6.11 Lashing cargo inside cargo transport units

Most cargo transport units are manufactured with lashing points or tie down points along the bottom and top rails. Such anchor points that are provided along the bottom rail are usually rated at 10 kN⁵⁰ in any direction. The Lashing points along the top side rails are usually rated at 5 kN. There is often also a tie bar running along the side walls at a height of about 1 metre above floor level. These are not designed to take substantial weights. There is no reason not to use lashing points where the cargo allows access, but blocking and bracing and gap filling is often a more effective method of securing cargo.

It is recognised that using straps and ropes to lash down cargo inside cargo transport units using the lashing points provided is difficult – much more difficult than lashing flat racks for instance, where good all-round access is available. Access inside the shipping container after and during packing cargo is usually awkward and restrictive, and it is often not easy to position the lashings where they would be most effective. It is therefore easier and more effective to fill the gaps between pieces of cargo inside box containers to prevent them from moving than to lash them using the lashing points.

A6.12 Container/vehicle packing certificate⁵¹

When dangerous goods have been packed into a cargo transport unit for sea, a packing certificate must be prepared and signed by the person responsible for packing the container, often the packer. This is often referred to as the 'Packing Certificate'.

This is a binding declaration signed by the packer to state that he has checked that the goods have been packed, segregated, marked, labelled and secured in the cargo transport unit in compliance with the provisions IMDG Code, and that cargo transport unit itself is fit to carry the goods.

A6.13 Placarding and marking cargo transport units⁵²

When dangerous goods have been packed into a shipping container, placards and marks must be fixed to the outside of the shipping container to indicate the hazard class or classes, including sub-hazards of the dangerous goods inside.

Placards must be fixed to both sides, front and back of the shipping container.

Note: The packer is responsible for attaching placards to the outside of the container.

⁵⁰ A kilonewton, being the measurement of the force required to accelerate a mass of one kilogram at a rate of one meter per second squared.

⁵¹ IMDG Code, 2020 Edition Amendment 40-20, Section 5.4.2

⁵² IMDG Code, 2020 Edition Amendment 40-20, Chapter 5.3

Single hazardous substance of Class 3 (less than 4000 kg)⁵³
 Diamond placard (250mm x 250mm) both sides and both ends of cargo transport unit

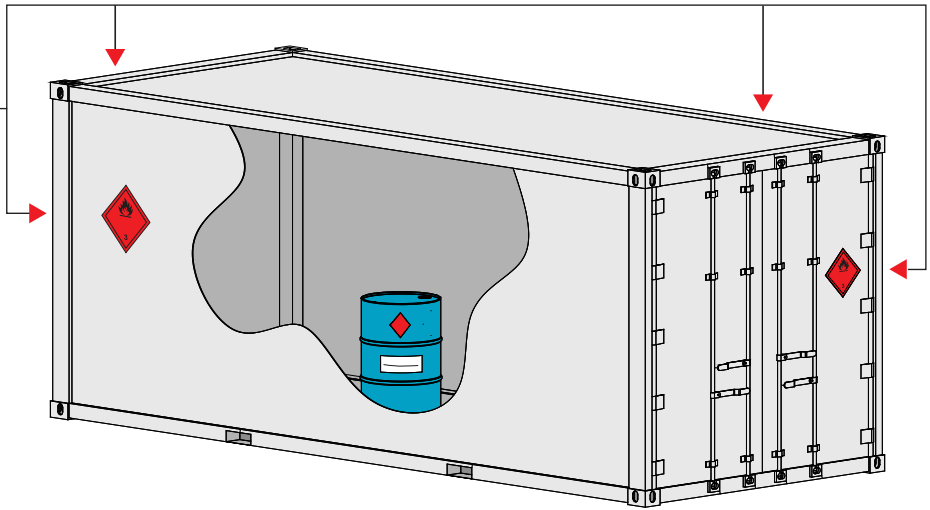

Single hazardous substance of Class 3 (more than 4000 kg)⁵⁴
 Diamond placard (250mm x 250mm) and UN Number on orange panel both sides and both ends of cargo transport unit

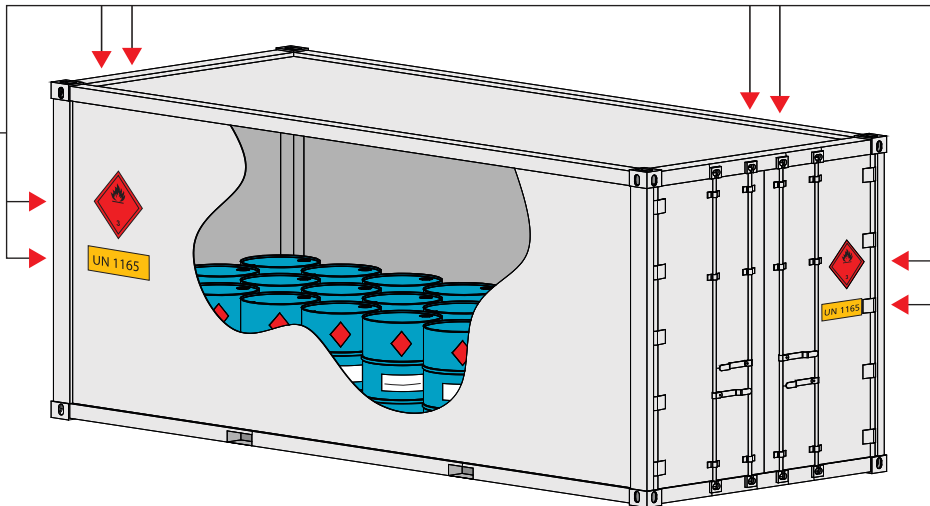

When it is required to display the UN Number, it can be displayed on white panels on the placards (left) or on separate orange panels (right).

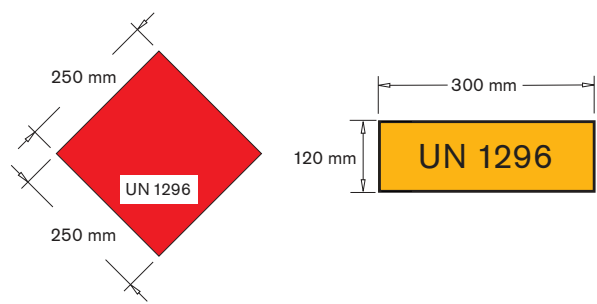

⁵³ IMDG Code, 2020 Edition Amendment 40-20, Section 5.3.1.1
⁵⁴ IMDG Code, 2020 Edition Amendment 40-20, Section 5.3.2.1

Two substances of dangerous goods
Placard for both classes on both sides, front and rear of cargo transport unit

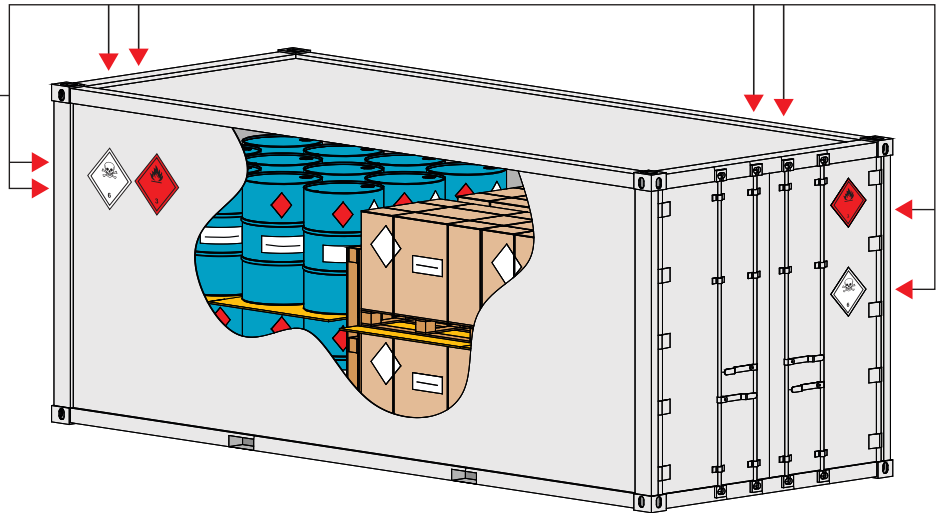

Placards required for two dangerous substances, both with a single hazard class

One dangerous substance with sub-hazards
If dangerous goods cargo has a sub-hazards, placards for the main hazard class and sub-hazard must be displayed
If there is a single substance more than 4000 kg the UN Number is added
Placard for both classes and UN Number on both sides, front and rear of cargo transport unit

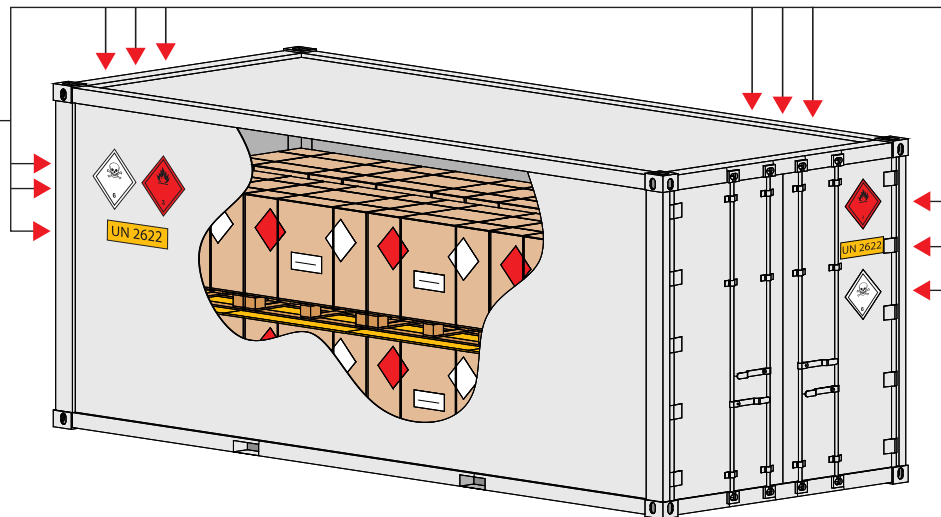

Placards and UN Number required for single substance with a sub-hazard, more than 4000 kg

When it is required to display the UN Number, it can be displayed on separate orange panels (right) or on white panels on the placards (left).

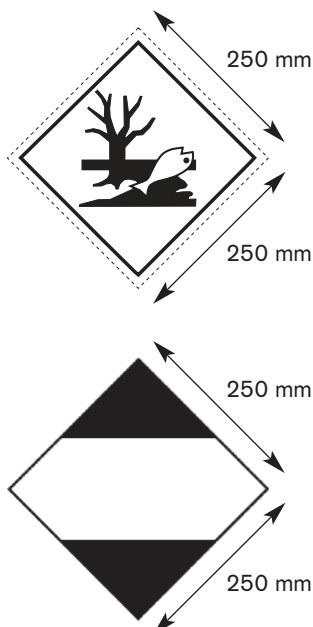

Marine pollutant mark⁵⁵

Marine pollutant marks must be displayed on both sides front and back of a shipping container that contains any dangerous goods classed as marine pollutant.

The marine pollutant mark is added to cargo transport units carrying substances that are environmentally hazardous but not otherwise dangerous, and also to substances that are classified as being both dangerous goods and also environmentally hazardous as a sub-hazard

Limited Quantities mark⁵⁶

Limited quantity marks must be displayed on both sides and front and back of a shipping container that contains dangerous goods in limited quantities only.

A CTU containing BOTH dangerous goods packed in "limited quantities" and other dangerous goods must be placarded and marked according to the provisions applicable to the other dangerous goods. No "limited quantities" mark is required on the CTU in this instance.

⁵⁵ IMDG Code, 2020 Edition Amendment 40-20, Section 5.3.2.3

⁵⁶ IMDG Code, 2020 Edition Amendment 40-20, Section 5.3.2.4

Step 7: The packing certificate⁵⁷

A7 The purpose of the packing certificate

After dangerous goods have been packed into any cargo transport unit (containers or vehicles) for a maritime journey a certificate must be signed to certify that the dangerous goods have been properly marked and labelled, segregated, secured, that no leaking packages were packed, and the container has been correctly placarded and that the packages and the cargo transport unit comply with every requirement of the IMDG code.

A7.1 Who signs the packing certificate?

The person directly controlling the cargo transport unit packing operation is responsible for signing the packing certificate.

Shippers can only sign packing certificates if they also control the cargo transport unit packing operation. Shippers that pack their own dangerous goods into cargo transport units become the packers and are legally obliged to complete and sign the packing certificate section of the dangerous goods transport document as well as the shipper's declaration.

Shippers should not issue shipper's declarations to any third party with the packing certificate signed before the cargo transport unit has been packed. Shippers who arrange for third parties to pack their dangerous goods into cargo transport units on their behalf should never complete or sign the packing certificate at any stage.

A7.2 Packing certificate on a combined document

Most organisations use a dangerous goods transport document based on the UN multimodal document that includes both the shipper's declaration and the packing certificate on a single document – a "combined document". See related information in Section A4.4 and a completed example of the UN multimodal document illustrated below.

Shippers using a third party to pack their dangerous goods will complete and sign the shipper's declaration section on the combined document, and send that with the dangerous goods to the packer.

The packer must ensure that he completes and signs the packing certificate section of the dangerous goods transport document after the dangerous goods have been packed and the cargo transport unit has been sealed for transport.

The shipping line will require a signed copy of the packing certificate before loading the cargo transport unit to a ship.

A7.3 Legal status of the packing certificate

Like the shipper's declaration, the packing certificate is also a legal declaration. No technical details about the dangerous goods are added by the packer, he only adds his signature, name, status, company and date of signing to the document, but by doing so he creates a legally binding statement that he accepts responsibility for the safe condition, marking, labelling, placarding, packing and securing of the dangerous goods in the cargo transport unit, and the structural integrity of the unit itself.

⁵⁷ IMDG Code, 2020 Edition Amendment 40-20, Section 5.4.2



MULTIMODAL DANGEROUS GOODS FORM - IMDG Code Amendment 40-20

1 Shipper/Consignor/Origin Exis 3 Trinity Ct Darlington DL30PH UNITED KINGDOM		2 Transport document number SHIP-16062022		
		Page 1 of 1 pages		4 Shipper's reference #00001
		5 Freight forwarder's reference		
6 Consignee Gent Technologies Waterloo Industrial Estate Gent Holland		7 Carrier (to be completed by the carrier) Exis Shipping Lines		
8 This shipment is within the limitations prescribed for: <input checked="" type="checkbox"/> PASSENGER AND CARGO <input checked="" type="checkbox"/> CARGO ONLY		SHIPPER'S DECLARATION I hereby declare that the contents of this consignment are fully and accurately described below by the Proper Shipping Name, and are classified, packaged, marked and labelled/placarded and are in all respects in proper condition for transport according to the applicable international and national governmental regulations.		
10 Vessel/flight No. and date Exis Trident	11 Port/place of loading Teesport	9 Additional handling information		
12 Port/place of discharge Antwerp	13 Destination Gent			
14 Shipping marks Number and kind of packages, description of goods*		Gross mass (kg)	Net Mass (kg)	Cube (m ³)
Processed on Hazcheck Online using IMDG Code Amendment 40-20				
UN 2455, 2-CHLOROPROPENE, Class 3, PG I, (D/E), (-25°C), EmS F-E,S-D		2200		
200 x 1N1 Other metal drums, non-removable head, Total Capacity 2000 L				
UN 1234, METHYLAL, Class 3, PG II, (D/E), (-28°C c.c.), EmS F-E,S-D		1100	1000	
Inner:1000 x Glass. Outer:100 x 4G Fibreboard boxes, Total Capacity 1000 L				
Carriage in accordance with ADR 1.1.4.2.1				
15 Container identification No./ vehicle registration No. CPSU565657-1	16 Seal number(s) 657578	17 Container/vehicle size and type 20 x 8.6 Box	18 Tare mass (kg) 4500	19 Total gross (incl. tare) (kg) 7800
CONTAINER/VEHICLE PACKING CERTIFICATE I hereby declare that the goods described above have been packed/loaded into the container/vehicle identified above in accordance with the applicable provisions.** MUST BE COMPLETED AND SIGNED FOR ALL CONTAINER/VEHICLE LOADS BY PERSON RESPONSIBLE FOR PACKING/LOADING		21 RECEIVING ORGANIZATION RECEIPT Received the above number of packages/containers/trailers in apparent good order and condition, unless stated hereon. RECEIVING ORGANIZATION REMARKS:		
20 Name of company Exis consignors		22 Name of company (OF SHIPPER, PREPARING THIS NOTE) Exis consignors		
Name/status of declarant Will Bartle/Packer		Name/status of declarant Will Bartle/Packer		
Place and date Teesport 16th Jun 2022		Place and date Teesport 16th Jun 2022		
Signature of declarant W BARTLE		DRIVERS SIGNATURE W BARTLE		

* DANGEROUS GOODS

You must specify: Proper Shipping Name, hazard class, UN No., Packaging group, (where assigned) marine pollutant and observe the mandatory requirements under applicable national and international governmental regulations. For the purposes of the IMDG Code see 5.4.1.4.

** For the purposes of the IMDG Code see 5.4.2.

A7.4 Legally binding statement by the cargo consolidator / cargo transport unit packer⁵⁸

The specific safety factors concerning the packing of dangerous goods into a cargo transport unit for which the packer accepts responsibility are set out in clauses on the reverse page of the UN model dangerous goods form that is reproduced in the IMDG Code:

⁵⁸ IMDG Code, 2020 Edition Amendment 40-20, Section 5.4.5.1

The signature given overleaf in box 20 must be that of the person controlling the container/vehicle operation.

When materials are transported in bulk packagings, the cargo has been evenly distributed in the container/vehicle.

It is certified that:

The packages and the container/vehicle have been properly marked, labelled and placarded. Any irrelevant mark, labels and placards have been removed.

If the consignments include goods of class 1, other than division 1.4, the container/vehicle is structurally serviceable.

When substances presenting a risk of asphyxiation are used for cooling or conditioning purposes (such as dry ice (UN 1845) or nitrogen, refrigerated liquid (UN 1977) or argon, refrigerated liquid (UN 1951)), the container/vehicle is externally marked in accordance with 5.5.3.6.

No incompatible goods have been packed into the container/vehicle unless specially authorized by the competent authority.

When this Dangerous Goods Form is used as a container/vehicle packing certificate only, not a combined document, a dangerous goods Declaration signed by the shipper or supplier must have been issued/ received to cover each dangerous goods consignment packed in the container/vehicle.

All packages have been externally inspected for damage and only sound packages packed.

Drums have been stowed in an upright position unless otherwise authorized by the competent authority.

All packages have been properly packed and secured in the container/vehicle.

Note: *The container/vehicle packing certificate is not required for tanks.*

A7.5 Summary of the provisions of the packing certificate

In summary, the packing certificate certifies that the dangerous goods packages were properly marked and labelled, packed in good condition, properly segregated following IMDG Code rules, the cargo transport unit was itself in good condition, and the goods were packed and secured in a fit state to withstand a journey by sea, and the cargo transport unit was marked and placarded according to IMDG requirements.

The final objective: Safely loading containers to the ship

Loading the ship – the role of the cargo planner

After the packer shuts the doors on a cargo transport unit and applies the security seal, under normal circumstances no-one will see inside a container until it reaches its destination. The cargo transport unit will be delivered to the marine terminal where it will wait its turn to be hoisted aboard a ship with hundreds of others, and the sea journey will begin.

The position where dangerous goods are stowed on the ship is carefully selected by specialists called cargo planners, and the safety of the ship depends on their decisions. The position is chosen by the cargo planner based on the dangerous goods information given to him by the shipping line booking staff originating from the shipper or forwarder, and the container packer.

This is safety critical information for the ship. The data passes through many hands to the cargo planner so it is vital that the data is correct and comprehensive and does not get omitted, altered or shortened. This could lead the planner to create a stowage that makes the ship unsafe.

Precise and comprehensive information is vital to the plan

It is of absolute and utmost importance that packers declare EXACTLY what items of dangerous goods are in the consignments they have booked. There must be no hidden dangerous goods. There must be absolutely NO QUESTION that all dangerous goods have been declared to the shipping line and the identity and details are included on the transport document.

If there are one, two, three or more types of dangerous goods in a freight container the packer must tell the shipping line about each and every one.

Only with this assurance can the cargo planners stow the cargo on the ship in a safe way.

In view of the frequency and severity of incidents, the IMO has set out guidance⁵⁹ in relation to inspection programmes for cargo transport units, encouraging governments to undertake CTU inspections and report their findings.

A number of container shipping lines have additionally implemented inspection programmes in order both to enhance safety aboard their ships and improve good practice amongst shippers.

Further the Cargo Incident Notification System (CINS) was launched in September 2011 to increase safety in the supply chain, reduce the number of cargo incidents on board ships and on land, and highlight the risks caused by certain cargoes and/or packing failures. CINS enables analysis of operational information on cargo and container incidents which lead to injury or loss of life, loss or serious damage of assets and environmental concerns.

Undeclared dangerous goods are totally unacceptable for carriage by sea

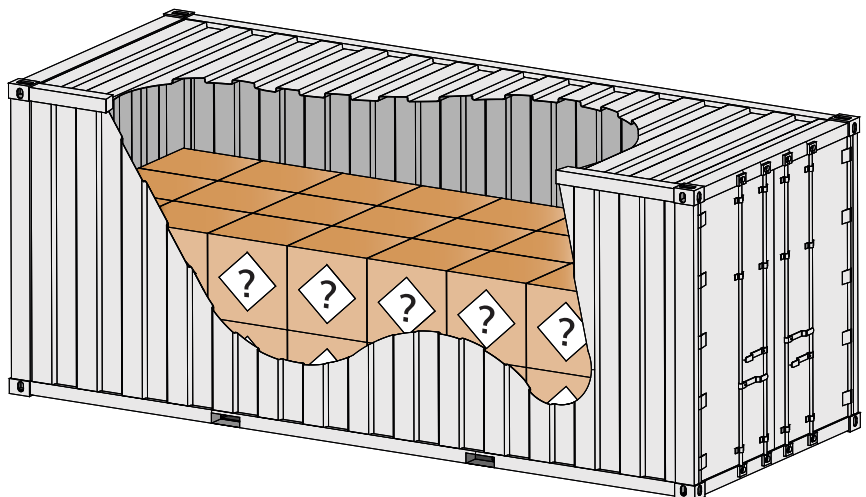

⁵⁹ IMO circular MSC.1/Circ.1442 issued 1 June 2012

Calculating stowage and segregation

Planning where to put containers on a container ship is a complex and precise operation. The planners will choose a location for every individual dangerous goods container based on what they know about the design of the ship and what they have been told about the dangerous goods by the shipper and packer. Containers may be buried deep in the hold of a ship, positioned on deck where the crew can carry out daily monitoring, stowed as far as possible from the crew's quarters, stowed where they will not be exposed to heat, or stowed away from other dangerous goods.

Stowage on the ship

Stowage means "where on the ship" a container is put. This is an important decision that can only be taken when the design of the ship and the dangerous goods cargo details are known. Bearing in mind that turnaround in a single port call may run into thousands of containers on and off a 20,000 TEU ultra large container ship, this is a challenging operation.

Despite the numbers, the cargo planners choose an exact location on the ship for every dangerous goods shipping container, based on the data provided by the shipper. Cargoes that have to be monitored must be located on deck, heat sensitive cargoes must be located where they will not be affected by sources of heat, and incompatible cargoes must be physically kept apart.

Segregation of dangerous goods on the ship

Segregation as applied to ship stowage means not loading containers carrying incompatible dangerous goods next to or close to each other. They will be located at a distance apart on the ship⁶⁰. The rules are strictly adhered to in order to minimise a reaction in dangerous goods in one container spreading to dangerous goods in adjacent containers. Some substances are considered such a high risk combination they must be separated on the ship by at least two fireproof walls.

Despite the fact that dangerous goods appear visually to be intrinsically safe in their containers, evidence from ship fires is very much the opposite. When involved in fires on ships, heat inside containerised cargo builds up to the ignition point of the cargo surprisingly quickly, and being encased in the container, the fire fighting water or CO₂ is prevented from reaching the seat of fire. Once a fire takes hold on a ship it is very difficult to contain, and below deck they are practically impossible to access.

Knowing exactly what dangerous goods are in a container, and where they are on the ship is paramount in the minds of ship planners and ship's crews, and all depends on the accuracy of the information supplied by the shipper and the packer.

Protecting temperature-sensitive substances from sources of heat

Some substances are sensitive to heat and will begin an uncontrollable polymerizing or self-heating reaction if exposed to raised temperatures. Stabilization and thermal control are used to counter-act this, but locating them on the ship where they will not be exposed to local sources of heat is critical. Heat can come from three sources:

Heat from the ship's machinery

The largest container ships are 400 metres long and carry over 20,000 TEU (20' equivalent containers). Ship's engines and other machinery needed to power such ships are equally massive, and generate huge amounts of heat in steam pipes, exhaust pipes and fuel heaters that can be adjacent to cargo carrying spaces.

Heat from the sun

Contents of containers carried on deck that are fully exposed to the sun can also reach very high temperatures and in tropical regions temperatures of up to 60°C have been recorded by monitoring devices inside cargo transport units.

Heat from other cargo

Some cargoes are carried in tanks at an elevated temperature to keep them from solidifying from the liquid to the solid state. Cargo stowed adjacent to them will be directly affected.

⁶⁰ IMDG Code, 2020 Edition Amendment 40-20, Chapters 7.1 and 7.2

Areas that ship planners must avoid when stowing heat sensitive cargoes

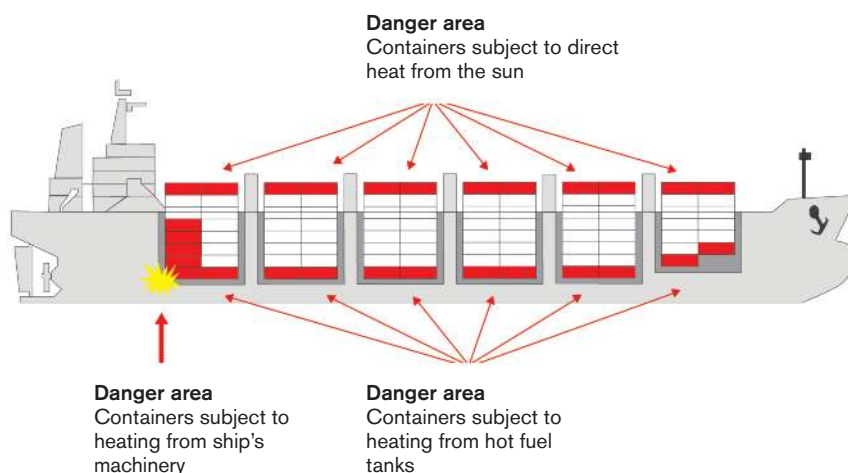

Example

UN 2880, CALCIUM HYPOCHLORITE, 5.1

Stowage instructions include: "SW1 Protected from sources of heat" and "SW11 Cargo transport units shall be shaded from direct sunlight..."

These instructions tell the ship planner that he must not allow the container to be placed in the ship close to hot machinery, fuel heaters or steam or exhaust pipes, or in an exposed location on deck where it can be heated directly by sunlight.

Ship planners depend on the shipper's information to load a safe ship

Ship planners use sophisticated planning software to assist them handle the huge numbers of containers involved in ship port operations when creating a stowage plan in compliance with the IMDG Code rules. However, that software, the sophisticated resources of the shipping line and the skill and experience of the ship planners is useless and ineffective if the basic information provided by the shipper is wrong, or there is information missing, whether accidentally or deliberately.

WARNING!

Ship planners depend entirely on the accuracy of information supplied by the shipper and container packer.

If you do not report every UN Number, the proper ship segregation and stowage checks cannot be made.

Missing or inaccurate dangerous goods information will result in unsafe stowage.

If you fail to declare, you place the ship in danger and are in breach of state legislation.

In the event that mis-declaration leads to an incident, you render yourself liable for civil court action for damage recovery and injury compensation.

A more detailed and extensive description of the issues concerning stowage of dangerous goods on board ships can be found in the CINS publication, "Safety Considerations for Ship Operators Related to Risk-Based Stowage of Dangerous Goods on Containerships".⁶¹

⁶¹ www.cinsnet.com/wp-content/uploads/2019/11/CINS-DG-Stowage-Considerations-Final.pdf

Conclusion

We hope that you find this guide book helpful. If you are a shipper, apart from classifying your cargo accurately, is important for you to ensure that the packaging you have selected is suitably robust for the rigours of a maritime journey. As well as being subjected to the vibration and stop/start forces of road or rail journey to and from a port, your cargo transport unit may be loaded onto and discharged from several ships before reaching its destination, and be subjected to the lateral and vertical centrifugal forces of ships at sea.

Beyond that we hope we have shown how important it is that the information and documentation provided by shippers or forwarding agents to the shipping line is honest, comprehensive and accurately identifies the Proper Shipping Names of all the dangerous goods in the consignment along with packaging and quantities, and that the signature on the shipper's declaration is more than just a meaningless convention.

Shipping line booking staff have a responsibility to understand the nature of the dangerous goods and their potential hazards, and to insist that full details are provided, particularly for N.O.S. substances where the substances have an unlimited range of variable characteristics that do not appear in the IMDG Code as a simple look up.

Cargo transport unit packers have an over-arching responsibility and legal duty to ensure that dangerous goods packed for shipment by sea are secured against movement, not leaking, and packed in such a way that they are able to withstand the predictable forces that will be exerted on them. Packers are required to issue a signed packing certificate to confirm compliance with all aspects of the IMDG Code.

The supply chain demands more and more speed, electronic semi-automatic systems for booking and organising unit load movements are evolving and migrating into every aspect of logistics. Containerised movements are being concentrated into a smaller number of ever-larger ships and maritime terminals. Higher traffic volume is the aim of all organisations, and there is less time to scrutinise individual consignment details, and consequently the system demands a higher standard of professionalism from those processing the data.

UK P&I Club and TT Club offer this guide to encourage and support all those seeking a higher level of understanding and professionalism in the safe transport of dangerous goods by sea.



Part B: Reference and Classification

Introduction

The purpose of this reference section is to explain the main operational terms and provisions referenced to in the IMDG Code and Part A of this guide, and to provide some information on key issues.

B1 What are dangerous goods and how are they identified?

Dangerous goods are substances and articles that have the potential to kill or injure people, cause damage to ships and other transport equipment, damage the environment and disrupt the supply chain.

Some workers who handle dangerous goods do not recognise them for what they are because they have not been trained to do so. They do not know what dangerous goods are, and therefore cannot understand the hazards to themselves and others. This section includes a brief guide to the UN system for identification of types of dangerous goods.

Dangerous goods are classified and listed in the United Nations classification system. Classification test methods and classification criteria are described fully in the UN Manual of Tests and Criteria, and referred to in Part 2 of the International Maritime Dangerous Goods (IMDG) Code. Dangerous goods that are classified as dangerous for carriage by sea can be found listed and described in Part 3.2 of the IMDG Code in the "Dangerous Goods List". This lists all dangerous goods numerically by UN Number.

Substances and articles classified as dangerous goods or marine pollutants under the IMDG Code may not necessarily be classified as dangerous goods for carriage by local domestic, road or rail transport regulations. For example UN 1372, FIBRES ANIMAL or FIBRES VEGETABLE, burnt, wet or damp are not subject to the road transport regulations of ADR, but are subject to sea transport regulations of the IMDG Code.

Note: If the dangerous goods are to be transported by sea, it is the IMDG Code classification and rules that take precedence, but local regulations for transport by road or rail may also need to be considered to allow the unit to be delivered to the ship.

B2 Structure of the International Maritime Dangerous Goods (IMDG) Code

The international rules for shipping dangerous goods by sea in cargo transport units (containers and ro-ro vehicles) are contained in the IMDG Code, which is produced by the International Maritime Organisation (IMO) which is an agency of the United Nations. The Code is updated by the IMO with a new edition every two years⁶².

The IMDG Code is implemented through the international Convention for the Safety of Life at Sea (SOLAS). Nation states that sign up to the SOLAS Convention agree to enact domestic legislation to enforce the IMDG Code on their registered ships internationally and other ships in their territorial waters.

Any organisation involved in any way with the transport of dangerous goods by sea cannot function without reference to the IMDG Code.

⁶² The IMDG Code is developed from the UN Model Regulations, which are drawn up by the United Nations Economic and Social Council's Committee of Experts on the Transport of Dangerous Goods on a biennial basis. The Model Regulations aim to allow uniform development of regulations governing all modes of transport. See www.unece.org/trans/danger/publi/unrec/rev13/13nature_e.html

B2.1 Format of the IMDG Code

- Part 1** General Provisions, Definitions and Training (including forbidden goods, legal status and security)
- Part 2** Classification
- Part 3** Dangerous Goods List, Special Provisions and Exceptions (including segregation groups, Limited and Excepted Quantities)
- Part 4** Packing and Tank Provisions (Use of Packaging)
- Part 5** Consignment Procedures (including marking and labelling, placarding and marking CTUs, documentation and special provisions)
- Part 6** Construction and Testing of Packagings, IBCs, Large Packagings, Portable Tanks, MEGCs and Road Tank Vehicles
- Part 7** Provisions Concerning Transport Operations (including stowage and segregation)

B2.2 The Dangerous Goods List (numerical index)⁶³

The IMDG Code is the mandatory guidance document for manufacturers, shippers, cargo transport unit packers, forwarding agents, ports and of course mariners for carriage of dangerous goods on contain ships and ro-ro ships. All dangerous goods are listed in the Dangerous Goods List, which is in the form of a matrix and is the key point of reference to locate the rules for identification, packing, marking labelling and documenting any dangerous goods for sea.

Dangerous goods are listed numerically by their UN Number in the Dangerous Goods List which displays references at the head of each of 18 columns to where in the Code the relevant information for aspect of the Code can be found.

This is a simplified representation of the information that can be found in the 18 columns in the Dangerous Goods List. It shows the information that can be retrieved from the Dangerous Goods List for UN 2210, MANEB or MANEB PREPARATION with not less than 60% maneb.

1	2	3	4	5	6
UN Number	Proper Shipping Name	Class or division	Subsidiary hazard(s)	Packing group	Special provisions
2210	MANEB or MANEB PREPARATION with not less than 60% maneb	4.2	4.3 P	III	273

7a	7b	8	9	10	11
Limited Quantities	Excepted Quantities	Packing Instructions	Packing Provisions	IBC Instructions	IBC Provisions
0	E1	P002	PP100	IBC06	-

⁶³ IMDG Code, 2020 Edition Amendment 40-20, Chapter 3.2

12	13	14	15	16a	16b
Portable tanks and bulk containers			EmS	Stowage & handling	Segregation
-	Tank Instructions	Tank Provisions			
Col 12 no longer used	T1	TP33	F-G, <u>S-L</u>	Category A H1	SG26 SG29

17	18
Properties and observations	UN Number
Yellow powder, liable to heat and to ignite spontaneously in air. May evolve toxic, irritating or flammable fumes when wet, when involved in a fire or in contact with acids. Used as fungicide.	2210

If you are in the business of preparing dangerous goods documentation or packing dangerous goods for transport by sea, it is impossible to work safely and legally without reference to the instructions and information in the IMDG Code, using the Dangerous Goods List as the focal point of reference.

B2.3 The Alphabetical Index

At the end of Volume 2 of the Code there is an Index of Proper Shipping Names of dangerous goods listed alphabetically, showing the class and UN Number of each to enable reference to the full details in the Dangerous Goods List.

Included in this Index are synonyms, alternative names to those PSNs that occur in the dangerous goods list. If the word 'see' appears after the name of the substance, material or article, the name concerned is not the official description to be used when it is transported. The Proper Shipping Name and associated transport provisions can be found using the UN Number listed against it.

As an example, for chloroethane, the index includes the word 'see' and directs us to UN 1037 which has the correct Proper Shipping Name of 'ETHYL CHLORIDE'. This PSN is the one that must be included on the transport documentation.

B3 Classification of dangerous goods for transport

Before any substance is placed on the market, it should be subjected to a series of UN-specified tests to determine whether it has any dangerous properties such as flammability, toxicity, or whether it reacts with common substances making them dangerous for use or during transport. If a substance or article is found to have properties that make it potentially hazardous during transport it is classified under the UN system as "dangerous goods" and is included in the IMDG Code Dangerous Goods List.

Before offering dangerous goods for transport, the shipper must make a shipper's dangerous goods declaration. Therefore, it is the shipper's duty to obtain formal hazard classification from the manufacturer of the dangerous goods offered, or test it himself. Some classification test methods are described in IMDG Part 2, but in general the tests are specialised and outside the scope of this guide.

The following section on classification is to clarify which details derived from the UN classification system the shipper is required to provide to the shipping line when booking a consignment for carriage by sea in order to comply with the IMDG Code.

B3.1 What is classification of dangerous goods?

Before dangerous goods can be accepted for shipment by sea, the shipper must ensure he has obtained a classification resulting from standard UN hazard identification tests.

These tests enable hazard classification (Proper Shipping Name, UN Number, hazard class, packing group and other dangerous goods details demanded on documentation by the IMDG Code) to be identified and submitted to the shipping line. The shipper must present a signed dangerous goods declaration document containing these same dangerous goods details to the person designated to pack the cargo transport unit. The shipper's declaration is a binding agreement with the shipping line that the goods have been accurately described.

The IMDG Code requires that dangerous goods are classified into one of nine main hazard classes, according to the nature of the hazard. These classes are described below one by one.

Some of the nine classes are sub-divided. Each class and class sub-division is represented by a different diamond shaped identification symbol.



The first process of classification identifies substances or articles as having characteristics that place it in one or more of the nine dangerous goods classes described below⁶⁴.

Having identified the class, the classification process continues to determine the UN Number, Proper Shipping Name, packing group and other details to exactly identify the hazardous properties of each substance.

B3.2 Classification by hazard class (IMDG Part 2 – Classes 1 to 9)

There are standard UN classification test methods prescribed to identify each class. The less technically complex tests are included in IMDG Part 2. These tests will determine what class, or class sub-division a particular dangerous substance will be assigned. If there is more than one dangerous characteristic, a subsidiary hazard will be added to the main class.

⁶⁴ See IMDG Code, 2020 Edition Amendment 40-20, Chapters 2.1 to 2.9 for full details

-
- Class 1: Explosives⁶⁵** (*sub-divided according to the type of hazard*)
- Class 1.1 – Substances and articles which have a mass explosion hazard
 - Class 1.2 – Substances and articles which have a projection hazard but not a mass explosion hazard
 - Class 1.3 – Substances and articles which have a fire hazard and either a minor blast hazard or a minor projection hazard or both, but not a mass explosion hazard
 - Class 1.4 – Substances and articles which present no significant hazard
 - Class 1.5 – Very insensitive substances which have a mass explosion hazard
 - Class 1.6 – Extremely insensitive articles which do not have a mass explosion hazard
- Class 2: Gases⁶⁶** (*sub-divided according to the type of hazard*)
- Class 2.1 – Flammable gases
 - Class 2.2 – Non-flammable, non-toxic gases
 - Class 2.3 – Toxic gases
- Class 3: Flammable liquids⁶⁷**
- Class 4: Flammable solids⁶⁸** (*sub-divided according to the type of hazard*)
- Class 4.1 – Flammable solids, self-reactive substances, solid desensitized explosives and polymerizing substances
 - Class 4.2 – Substances liable to spontaneously combustion
 - Class 4.3 – Substances which, in contact with water, emit flammable gases
- Class 5: Oxidising substances and organic peroxides⁶⁹**
(*sub-divided according to the type of hazard*)
- Class 5.1 – Oxidising substances
 - Class 5.2 – Organic peroxides
- Class 6: Toxic and infectious substances⁷⁰**
(*sub-divided according to the type of hazard*)
- Class 6.1 – Toxic substances
 - Class 6.2 – Infectious substances
- Class 7: Radioactive material⁷¹**
- Class 8: Corrosive substances⁷²**
- Class 9: Miscellaneous dangerous substances and articles (class 9) and environmentally hazardous substances and marine pollutants⁷³**
-

Class 1 – Explosives: hazard divisions 1.1 – 1.6⁷⁴

The range of substances and articles classified as explosives is wide and covers a range of risks and hazards. Therefore, explosives are sub-divided into “hazard divisions” to indicate the nature and degree of hazard as follows:

⁶⁵ IMDG Code, 2020 Edition Amendment 40-20, Chapter 2.1

⁶⁶ IMDG Code, 2020 Edition Amendment 40-20, Chapter 2.2

⁶⁷ IMDG Code, 2020 Edition Amendment 40-20, Chapter 2.3

⁶⁸ IMDG Code, 2020 Edition Amendment 40-20, Chapter 2.4

⁶⁹ IMDG Code, 2020 Edition Amendment 40-20, Chapter 2.5

⁷⁰ IMDG Code, 2020 Edition Amendment 40-20, Section 2.6

⁷¹ IMDG Code, 2020 Edition Amendment 40-20, Section 2.7

⁷² IMDG Code, 2020 Edition Amendment 40-20, Section 2.8

⁷³ IMDG Code, 2020 Edition Amendment 40-20, Section 2.9



Class 1.1 – Substances and articles which have a mass explosion hazard

If one part of a consignment of 1.1 explosives detonates, it is likely that the entire consignment will detonate simultaneously in a single mass explosion. The size of the explosive blast would be related to the quantity of explosives in the consignment.

Example: UN 0034, BOMBS, with bursting charge

On Division 1 labels:* = Place for compatibility group – to be left blank if explosive is the subsidiary hazard



Class 1.2 – Substances and articles which have a projection hazard but not a mass explosion hazard

If a consignment of 1.2 explosives is detonated, no mass explosion will result. However, there will be a projectile hazard and a series of smaller explosions is possible, throwing out projectiles that may themselves explode away from the original explosion.

Example: UN 0295, ROCKETS with bursting charge



Class 1.3 – Substances and articles which have a fire hazard and either a minor blast hazard or a minor projection hazard or both, but not a mass explosion hazard

If a consignment of type 1.3 explosives is detonated, there will be a major fire hazard and minor blast or minor projectile hazard, but not a mass explosion hazard.

Example: UN 0186, ROCKET MOTORS



Class 1.4 – Substances and articles which present no significant hazard

If a consignment of type 1.4 explosives is detonated, there will be no major blast, projectile or fire hazard. Additionally, hazards from articles in Compatibility Group “S” will be largely confined to the packaging and will not hinder fire-fighting.

Example: UN 0066, CORD, IGNITER



Class 1.5 – Very insensitive substances which have a mass explosion hazard

Explosive substances which possess a major blast hazard but are so insensitive they are unlikely to detonate accidentally in the event of a fire.

Example: UN 0332, EXPLOSIVES, BLASTING, TYPE E



Class 1.6 – Extremely insensitive articles which do not have a mass explosion hazard

Explosive articles with negligible probability of accidental detonation during transport.

Example: UN 0486, ARTICLES, EXPLOSIVE, EXTREMELY INSENSITIVE

Explosives have a class, hazard division and uniquely a “compatibility group” and “NEC” (net explosive content).

Compatibility group (explosives only)⁷⁵

Uniquely, explosives are always allocated a compatibility group. This is a further sub-classification of Class 1 (explosives) to indicate the segregation requirements of a given explosive from other types of explosives in all modes of transport.

The compatibility group is indicated by a letter A, B, C, D, E, F, G, H, J, K, L, N or S. Mixed packing of explosives (packing explosives of different compatibility groups in the same freight container other than with compatibility group "S") is generally prohibited because mixing types of explosives can increase the risk and consequences of an accidental detonation. There are exceptions – mixed cargo prohibitions and permitted mixed consignments are displayed in a table in IMDG 7.2.7.

The class, hazard division and compatibility group and N.E.C. of explosives must always be included in the shipper's declaration to determine requirements for stowage and segregation and compliance with port explosive licence and ship insurance conditions.

Net explosive content (NEC)

This is the amount of explosive material in an explosive article or consignment, as opposed to the net weight of the article (e.g. the weight of explosive compound in a bomb, without the weight of the metal casing, fusing and other mechanisms). Also called the "net explosive quantity" (NEQ), "net explosive mass" or in the case of fireworks, the "powder weight".

Applies to Class 1 (Explosives) only, and must be included in documentation.

Details forwarded by the shipper on a Class 1 shipping document

- UN Number
- Proper Shipping Name
- Class 1
- Division 1.1, 1.2, 1.3, 1.4, 1.5 or 1.6
- Compatibility group A, B, C, D, E, F, G, H, J, K, L, N or S
- Sub-hazard (if applicable)
- NEC (Net Explosive Content – i.e. amount of explosive compound in an article – also called the Net Explosive Quantity (NEQ))
- Marine pollutant (if applicable)
- Number and type of packages
- Net mass
- Gross mass

These details must be verified by a signed declaration from the shipper.

Class 2 – Gases (*sub-divided into 2.1, 2.2 and 2.3*)

Class 2 substances are gases at normal temperature and pressure. During transport they are compressed, liquefied, refrigerated, dissolved in a liquid solvent or adsorbed onto a solid porous material. Escaped gas may be heavier than air, may travel some distance from the source, and create explosion, asphyxiation or toxicity hazard in ships and buildings, being liable to collect in the lowest connected level. Class 2 includes manufactured articles such as aerosols, lighters, lighter refills, fire extinguishers and fuel cell cartridges charged with compressed or liquefied gas.

The class is sub-divided according to the different properties of the gas:

⁷⁵ IMDG Code, 2020 Edition Amendment 40-20, Section 2.1.2



Class 2.1 – Flammable gases⁷⁶

Flammable gas mixed with air can be ignited by a spark or source of heat to cause an explosion in open or enclosed space or inside a containment vessel.

Example: UN 1978, PROPANE

Note: This label may also be used with the symbol, line and “2” in white on a red background.

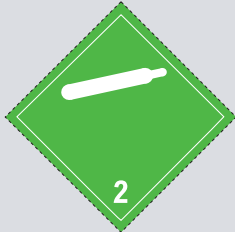

Class 2.2 – Non-flammable, non-toxic gases⁷⁷

Risk of asphyxiation of persons in enclosed spaces, or oxidizing gases which may, generally by providing oxygen, cause or contribute to the combustion of other material.

Example: UN 1013, CARBON DIOXIDE

Note: This label may also be used with the symbol, line and “2” in black on a green background.



Class 2.3 – Toxic gas⁷⁸

Inhalation of toxic gas can lead to death or injury to persons. Toxic gas may travel some distance from the original leak, through ships, buildings and open space, and may have delayed health effects.

Example: UN 2199, PHOSPHINE

Details forwarded by the shipper on a Class 2 shipping document

- UN Number
- Proper Shipping Name
- Class 2
- Division 2.1, 2.2 or 2.3
- Sub-hazard (if applicable)
- Marine pollutant (if applicable)
- Number and type of packages
- Net mass of liquid gas product or liquid volume of compressed gas container
- Gross mass

These details must be verified by a signed declaration from the shipper.



Class 3 – Flammable liquids⁷⁹

The UN classification system classes liquids as flammable if they have a “flashpoint” of 60°C or below. Flashpoint is the lowest temperature at which a liquid produces vapour that will ignite on exposure to an open flame or spark and the flashpoint must be quoted in the transport document.

Note 1: Flammable liquids will not self-ignite at their flashpoints – they self-ignite at their “ignition temperature”, which is higher.

Note 2: This label may also be used with the symbol, line and “3” in white on a red background.

Example: UN 1207, HEXALDEHYDE

⁷⁶ IMDG Code, 2020 Edition Amendment 40-20, Section 2.2.2.1

⁷⁷ IMDG Code, 2020 Edition Amendment 40-20, Section 2.2.2.2

⁷⁸ IMDG Code, 2020 Edition Amendment 40-20, Section 2.2.2.3

⁷⁹ IMDG Code, 2020 Edition Amendment 40-20, Chapter 2.3

Class 3 includes flammable viscous substances such as adhesives, and substances transported at elevated temperatures in a liquid state that produce flammable vapour at the transport temperature if the transport temperature is mechanically maintained above 60°C.

Details forwarded by the shipper on a Class 3 shipping document

- UN Number
- Proper Shipping Name
- Class 3
- Sub-hazard (if applicable)
- Packing group (I, II or III)
- Flashpoint
- Marine pollutant (if applicable)
- Number and type of packages
- Net mass or volume of Class 3
- Gross mass

These details must be verified by a signed declaration from the shipper.

Class 4 – Flammable solids: (sub-divided into 4.1, 4.2 and 4.3)

Class 4 deals with substances, other than those classified as explosives, which, under conditions of transport, are readily combustible or may cause or contribute to a fire. There are three sub-divisions:



Class 4.1 – Flammable solids; substances liable to spontaneous combustion; substances which, in contact with water, emit flammable gases⁸⁰

This class includes:

Self-reactive substances;
Solid desensitized explosives;
Polymerizing substances and mixtures; and
A wide range of substances that are easily ignited by heat or friction.

Examples: UN 1332, METALDEHYDE, UN 3532, POLYMERIZING SUBSTANCE, LIQUID, STABILIZED, N.O.S.



Class 4.2 – Spontaneously combustible substances⁸¹

Includes pyrophoric solids and liquids that are liable to spontaneous heating or spontaneous combustion on contact with air, and self-heating substances that slowly generate heat on contact with air.

Example: UN 1381, PHOSPHORUS, WHITE DRY



Class 4.3 – Substances which, in contact with water, emit flammable gases⁸²

Solids and liquids which on contact with water react to produce dangerous quantities of flammable gas, and may produce sufficient heat to cause ignition.

Note: This label may also be used with the symbol, line and "4" in white on a blue background.

Example: UN 1428, SODIUM

⁸⁰ IMDG Code, 2020 Edition Amendment 40-20, Section 2.4.2

⁸¹ IMDG Code, 2020 Edition Amendment 40-20, Section 2.4.3

⁸² IMDG Code, 2020 Edition Amendment 40-20, Section 2.4.4

Details forwarded by the shipper on a Class 4 shipping document

- UN Number
- Proper Shipping Name
- Class/Division 4.1, 4.2 or 4.3
- Sub-hazard (if applicable)
- Packing group (I, II or III)
- Marine pollutant (if applicable)
- Control temperature (if carried under temperature control)
- Emergency temperature (if carried under temperature control)
- Number and type of packages
- Net mass or volume of Class 4.1, 4.2 or 4.3
- Gross mass

These details must be verified by a signed declaration from the shipper.

Class 5 – Oxidising substances (sub-divided into 5.1 and 5.2)



Class 5.1 – Oxidising substances⁸³

Substances that although not necessarily flammable in themselves, yield oxygen when involved in a fire, increasing the hazard and intensity of fire. May become highly flammable or spontaneously ignite if mixed with common organic materials such as flour, sawdust, oils or sugar.

Example: UN 2067, AMMONIUM NITRATE BASED FERTILIZER



Class 5.2 – Organic peroxides⁸⁴

These are substances liable to spontaneous, sometimes explosive, exothermic decomposition at normal or elevated temperatures or by contact with other substances. Temperature-controlled carriage is required for some peroxides. Extremely dangerous to the eyes – minimum contact with cornea of eye causes severe damage.

Note: The red/yellow version of this label may also be used with the symbol in white on the red background.

Example: UN 3109, ORGANIC PEROXIDE TYPE F, LIQUID

Details forwarded by the shipper on a Class 5.1 or 5.2 shipping document

- UN Number
- Proper Shipping Name
- Class/Division 5.1 or 5.2
- Sub-hazard (if applicable)
- Packing group (I, II or III)*
- Marine pollutant (if applicable)
- Control temperature (if carried under temperature control)
- Emergency temperature (if carried under temperature control)
- Number and type of packages
- Net mass
- Gross mass

*Organic peroxides have no packing group but are classified by hazard type A to G

These details must be verified by a signed declaration from the shipper.

⁸³ IMDG Code, 2020 Edition Amendment 40-20, Section 2.5.2

⁸⁴ IMDG Code, 2020 Edition Amendment 40-20, Section 2.5.3

Class 6 – Toxic and infectious substances (sub-divided into 6.1 and 6.2)



Class 6.1 – Toxic substances⁸⁵

These are substances that cause injury or death if they enter the human body. Entry can be by inhalation of dusts and vapours, accidental ingestion, or direct contact with the skin.

Toxic substances may be in the form of liquids, solids, powders or granules and precautions must be paid to avoid skin contact if packages are damaged.

Example: UN 1558, ARSENIC

Details forwarded by the shipper on a Class 6.1 shipping document

- UN Number
- Proper Shipping Name
- Class 6.1
- Sub-hazard (if applicable)
- Packing group (I, II or III)
- Marine pollutant (if applicable)
- Number and type of packages
- Net mass or volume of Class 6.1
- Gross mass

These details must be verified by a signed declaration from the shipper.



Class 6.2 – Infectious substances (biological hazard)⁸⁶

Substances of Class 6.2 contain live micro-organisms which could cause disease to humans or animals. They include bacteria, viruses, parasites, fungi, and other pathogens. Consignments may consist of infected products, decomposing organic material, diagnostic specimens, laboratory cultures, medical waste, clinical waste or non-sterile animal products.

Example: UN 2814, INFECTIOUS SUBSTANCE, AFFECTING HUMANS

Details forwarded by the shipper on a Class 6.2 shipping document

- UN Number 2814, UN Number 2900, UN Number 3373, UN 3291, or UN 3549
- Proper Shipping Name
- Class 6.2
- Number and type of packages
- Net mass or volume of Class 6.2
- Gross mass
- The full address or the consignee
- Name and telephone number of a responsible person
- These details must be verified by a signed declaration from the shipper.

These details must be verified by a signed declaration from the shipper.

⁸⁵ IMDG Code, 2020 Edition Amendment 40-20, Section 2.6.2

⁸⁶ IMDG Code, 2020 Edition Amendment 40-20, Section 2.6.3

Class 7 – Radioactive material⁸⁷

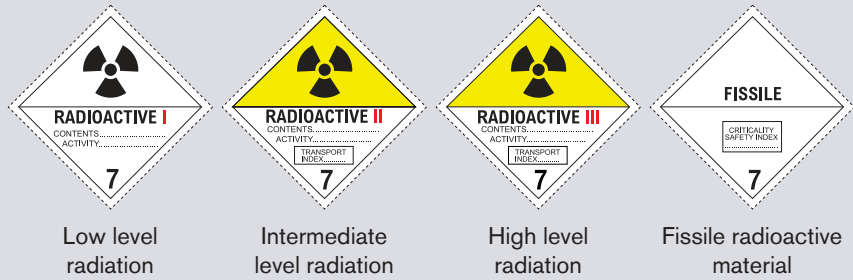

Substances that produce radioactivity above specified levels must be declared as radioactive material for shipment by sea. This includes packages and other objects that have become contaminated by radioactive material. Class 7 labels indicate the level of radioactivity, and whether the consignment contains fissile material.

Regardless of the nature of the radioactive material inside the package, the amount of detectable radiation outside the package is strictly controlled. This is achieved by shielding built into the inner packaging. Construction and design of transport packaging for radioactive materials are subject to strict international scrutiny and agreement. Provided the consignment was packed under controlled conditions by qualified persons, it will be safe to handle in transport, but of course packages of radioactive materials must never be opened or repaired without qualified supervision. Preparation of Class 7 shipments is complex and subject to specialised procedures beyond the scope of this guide⁸⁸.

Example: UN 2977, RADIOACTIVE MATERIAL, URANIUM HEXAFLUORIDE, FISSILE



Class 8 – Corrosive substances⁸⁹

Corrosive substances of Class 8 are those that destroy living tissue on contact. Certain corrosive materials corrode various metals, and some can corrode glass and earthenware. Some substances only become corrosive on contact with water or airborne moisture and form corrosive gases. Some corrosive substances react with organic materials to generate heat.

Class 8 substances include acids and alkalis that may react dangerously if mixed, requiring close attention to the IMDG Code segregation rules.

This class includes articles such as batteries that contain corrosive substances.

Example: UN 1789, HYDROCHLORIC ACID

Details forwarded by the shipper on a Class 8 shipping document

- UN Number
- Proper Shipping Name
- Class 8
- Sub-hazard (if applicable)
- Packing group (I, II or III)
- Marine pollutant (if applicable)
- Number and type of packages
- Net mass or volume of Class 8
- Gross mass

These details must be verified by a signed declaration from the shipper.

⁸⁷ IMDG Code, 2020 Edition Amendment 40-20, Chapter 2.7

⁸⁸ For the additional documentation requirements see IMDG Code, 2020 Edition Amendment 40-20, Section 5.4.1.5.7

⁸⁹ IMDG Code, 2020 Edition Amendment 40-20, Chapter 2.8

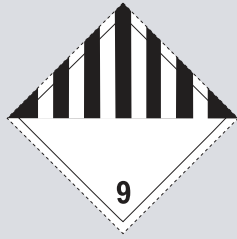

Class 9 – Miscellaneous dangerous substances and articles (class 9) and environmentally hazardous substances⁹⁰

Substances and articles of Class 9 generally do not fit into any other class, but may present significant risk under certain circumstances.

Class 9 covers a wide range of hazards, including goods that are only hazardous under certain conditions. It includes:

- substances and articles not covered by other classes which experience has shown, or may show, to be of such a dangerous character that the provisions of part A of chapter VII of SOLAS 1974, as amended, must apply.
- substances not subject to the provisions of part A in chapter VII of SOLAS 1974, but subject to the provisions of Annex III of MARPOL 73/78, as amended (marine pollutants).

Class 9 sub-divisions

The substances and articles of class 9 are subdivided as follows:

- **Substances which, on inhalation as fine dust, may endanger health** e.g. UN 2212, ASBESTOS, AMPHIBOLE
- **Substances evolving flammable vapour** e.g. UN 2211, POLYMERIC BEADS, EXPANDABLE, evolving flammable vapour
- **Lithium batteries** e.g. UN 3480, LITHIUM ION BATTERIES (including lithium ion polymer batteries)
- **Ammonium nitrate based fertilizers** e.g. UN2071, AMMONIUM NITRATE BASED FERTILIZE
- **Capacitors** e.g. UN 3499, CAPACITOR, ELECTRIC DOUBLE LAYER
- **Life-saving appliances** e.g. UN 2990, LIFE-SAVING APPLIANCES, SELF-INFLATING
- **Substances and articles which, in the event of fire, may form dioxins** e.g. UN 3432 POLYCHLORINATED BIPHENYLS, SOLID
- **Substances transported or offered for transport at elevated temperatures** e.g. UN 3258, ELEVATED TEMPERATURE SOLID, N.O.S., at or above 240°C
- **Environmentally hazardous substances** e.g. UN 3082, ENVIRONMENTALLY HAZARDOUS SUBSTANCE, LIQUID, N.O.S.
- **Genetically modified microorganisms (GMMOs) and genetically modified organisms (GMOs)** e.g. UN 3245, GENETICALLY MODIFIED ORGANISMS
- **Other substances or articles presenting a danger during transport but not meeting the definitions of another class** e.g. UN 3363, DANGEROUS GOODS IN ARTICLES

Environmentally hazardous substances (aquatic environment)⁹¹

Environmentally hazardous substances are liquid or solid substances which are pollutants to the aquatic environment and solutions and mixtures of such substances (such as preparations and wastes).

The classification criteria for environmentally hazardous substances (including solutions and mixtures) are detailed in depth in IMDG 2.9.3.2 to 2.9.3.4.

Note: For the purposes of the IMDG Code, the environmentally hazardous substances (aquatic environment) criteria contained in Chapter 2.9 apply to the classification of marine pollutants in Chapter 2.10 which we look at in the next section.

⁹⁰ IMDG Code, 2020 Edition Amendment 40-20, Chapter 2.9

⁹¹ IMDG Code, 2020 Edition Amendment 40-20, Section 2.9.3

Lithium batteries⁹²

Lithium batteries are a family of batteries with different chemistries, comprising many types of cathodes and electrolytes. There are two types covered in the IMDG Code:

Lithium metal batteries – these are generally primary (non-rechargeable) batteries that have lithium metal or lithium compounds as an anode. They are generally used to power devices such as watches, calculators etc

Lithium ion batteries – these are a secondary (rechargeable) battery where the lithium is only present in an ionic form in the electrolyte. They are generally used to power devices such as mobile telephones, laptops etc

Details forwarded by the shipper on a Class 9 shipping document

- UN Number
- Proper Shipping Name
- Class 9
- Packing group I, II or III (if applicable)
- Marine pollutant (if applicable)
- Number and type of packages
- Net mass or volume of Class 9
- Gross mass

These details must be verified by a signed declaration from the shipper.

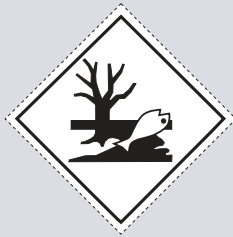

Packages and shipping containers carrying marine pollutants must display the marine pollutant mark

B3.3 Marine pollutants⁹³

Marine pollutants are defined in the IMDG Code as substances which are subject to the provisions of Annex III of Marpol 73/78, as amended.

Many dangerous substances assigned to classes 1 to 6.2, 8 and 9 are also deemed to be **marine pollutants** i.e. substances which are harmful to the marine environment because of their tendency to bioaccumulate harmful toxins in living seafood; or their high toxicity to aquatic life.

Known marine pollutants are identified as such by the inclusion of a 'P' symbol in column 4 of the DGL and in the 'MP' column in the Index of the IMDG Code.

It is important to note however, that even if a substance is not marked with a 'P' in the DGL (or 'MP' in the Index) it does not mean it isn't a pollutant; if it meets the criteria in IMDG 2.10.3 and 2.9.3 it must still be declared as a marine pollutant and shipped accordingly.

A marine pollutant which possesses properties of classes 1 to 8 must be classified (and identified) accordingly; if it doesn't meet the criteria for assignment to classes 1 to 8, it must be offered for transport under class 9 using one of the following entries: ENVIRONMENTALLY HAZARDOUS SUBSTANCE, SOLID, N.O.S. UN 3077, or ENVIRONMENTALLY HAZARDOUS SUBSTANCE, LIQUID, N.O.S. UN 3082. When transporting marine pollutants the shipper must include "Marine Pollutant" on the transport document and the goods must be declared, documented, marked, labelled and placarded as a marine pollutant.

Note: there is an exemption from all provisions of the IMDG Code for substances classified as marine pollutants if the following conditions apply:

- Single packages or inner packages of combination packages do not exceed 5 litres for liquids or 5 kg for solids (equivalent to Limited Quantity provisions)
- Packaging must meet the general packaging provisions of IMDG Part 4

⁹² IMDG Code, 2020 Edition Amendment 40-20, Section 2.9.4

⁹³ IMDG Code, 2020 Edition Amendment 40-20, Section 2.0.1.2 and Chapter 2.10

-
- The marine pollutant does not meet the classification criteria for any other hazard class

It is important to note that when marine pollutants also meet the criteria for inclusion in another hazard class, all the provisions of the Code relevant to any additional hazard(s) continue to apply.

B4 Subsidiary hazards (sub-hazards)

Most substances have a single dangerous property, and when classified this becomes the hazard "CLASS". Some substances have more than one dangerous property e.g. a toxic liquid may also be flammable. The degrees of hazard for each property of a substance are determined by classification. These are then compared against each other in a UN Table of Hazard Precedence (IMDG 2.0.3). The table will indicate which of the hazards is the most prominent, and this becomes the CLASS. The hazard(s) judged to be the lesser hazard(s) becomes the "SUBSIDIARY HAZARD(S)".

Any class of dangerous goods except Class 9 may potentially have a subsidiary hazard.

When describing dangerous goods in any document, any applicable sub-hazards must be included in brackets after the main class e.g. UN 3405, BARIUM CHLORATE SOLUTION, 5.1, (6.1)

B5 Entries in the Dangerous Goods List: UN Numbers and Proper Shipping Names⁹⁴

Substances classified into one of the classes of hazardous goods under the UN system are allocated a universally agreed name by a United Nations agency called the Committee of Experts on the Transport of Dangerous goods. This is the "PROPER SHIPPING NAME" and it is listed in Column 2 of the IMDG Dangerous Goods List, and in the IMDG alphabetical Index.

Every substance or article or generic N.O.S. hazard category that has a Proper Shipping Name is also allocated a unique four-digit number, hence the numbers are known as "UN Numbers".

The UN Number is entered in Column 1 of the Dangerous Goods List (IMDG 3.2) and is the required starting point for obtaining data from the Dangerous Goods List. The Proper Shipping Name is entered in Column 2.

This number is intermodal and assists greatly in avoiding errors by providing a simple check when transposing names of chemicals with long complex chemical names in a different language, during documentation and emergency response.

B5.1 The four types of Proper Shipping Name entries in the Dangerous Goods List⁹⁵

Type 1: Single-substance entries for well-defined individual substances or articles

For pure substances entered in the Dangerous Goods List, the UN Number and Proper Shipping Name can stand alone:

Example: "UN 2022, CRESYLIC ACID"

Type 2: Group entries for well-defined groups of substances or articles

Some types of substance or article differ in composition but have identical hazard characteristics, so as far as transport is concerned may be treated as alike:

Examples: "UN 1133, ADHESIVES" and "UN 1266, PERFUMERY PRODUCT"

⁹⁴ IMDG Code, 2020 Edition Amendment 40-20, Section 2.0.2

⁹⁵ IMDG Code, 2020 Edition Amendment 40-20, Section 2.0.2.2

Type 3: Group entries for substances with a similar chemical or technical nature

Some types of substance have different names but similar chemical composition, so as far as transport is concerned may be treated as alike:

Examples: "UN 1477, NITRATES, ORGANIC, N.O.S." and "UN 1987, ALCOHOLS, N.O.S."

Type 4: General N.O.S. entries used to classify products made from mixtures of substances meeting the criteria of one or more hazard classes

Combining or diluting chemicals has the effect of altering the hazard characteristics of the component substances from those of the pure state to something else, and there are limitless ways in which chemical substances can be combined to make useful products.

It is not practicable to make an entry in the Dangerous Goods List for every possible combination of components, so N.O.S. generic names are used to overcome this. N.O.S. Proper Shipping Names describe the hazard classification, not the substance. There is an extensive list of N.O.S. generic names in IMDG Appendix A. When the classification process is completed, the most appropriate N.O.S. Proper Shipping Name in Appendix A is chosen from the list⁹⁶.

N.O.S. Proper Shipping Names are shown in Column 2 of the Dangerous Goods List but only the generic part of the name describing the hazard, e.g. "FLAMMABLE LIQUID, N.O.S." and this is usually not the full Proper Shipping Name. With exceptions, in most cases N.O.S. entries are allocated Special Provision SP 274 which requires the Proper Shipping Name to be supplemented with the technical name of the dangerous components of the mixture. At least one technical name must be added in brackets after the generic description to provide emergency information. If there is more than one hazardous component, only the names of the two most hazardous components need be identified in this way.

The technical names are added in brackets after the generic description to provide emergency information. If there is more than one hazardous component, only the names of the two most hazardous components need be identified in this way.

Example 1: a 75% solution of propanol (flammable liquid) in water would not have the same characteristics as pure propanol so it would be classified as: "UN 1993, FLAMMABLE LIQUID N.O.S. (Contains propanol), 3"

Example 2: A liquid mixture containing 15% hydrochloric acid (corrosive) and 60% arsenic (toxic) would not be classified as either arsenic or hydrochloric acid, so would be classified under the N.O.S. criteria as: "UN 3289 TOXIC LIQUID, CORROSIVE, INORGANIC N.O.S. (Contains arsenic and hydrochloric acid), 6.1 (8)."

Additional information the shipper may need to supply for N.O.S. substances

For defined substances such as ADHESIVES, the variable dangerous goods details are tabulated in the Dangerous Goods List. For N.O.S. substances, because of their variable component range, the shipper may have to obtain any of the following factors from his classification and include them in his declaration:

- Packing Group (IMDG 2.0.1.3)
- Flashpoint (flammable liquids only)
- Marine pollutant (IMDG 2.10 and 2.0.1.2)
- Segregation group* (IMDG 3.1.4, and 7.2.5)
- Control and Emergency temperatures (5.4.1.5.4)

* If it is appropriate that an N.O.S substance should be included in one of the 18 segregation groups (see IMDG 3.1.4) the shipper shall include that segregation group in his cargo booking and shipper's declaration (see also Part A Segregation).

⁹⁶ IMDG Code, 2020 Edition Amendment 40-20, Sections 2.0.2.2 and 3.1.2.8

B6 Packing groups⁹⁷

For packing purposes, substances other than those of classes 1, 2, 5.2, 6.2 and 7, and other than self-reactive substances of class 4.1, are assigned to three packing groups in accordance with the degree of danger they present:

Packing Group I – High danger
Packing Group II – Medium danger
Packing Group III – Low danger

If applicable the relevant packing group is shown in column 5 of the DGL. The criteria for determining the packing group is found in the classification section of each applicable class in IMDG Part 2.

Note, articles are not assigned to packing groups, rather the specific packaging performance test is set out in the applicable packing instruction.

Packing groups are not assigned to articles or to explosives of Class 1 or gases of Class 2. Organic peroxides of Class 5.2 and self-reactive substances of Class 4.1 do not have packing groups but are allocated a Type (A to G) according to degree of danger⁹¹.

Rules for determining packing groups and types are found in IMDG Chapter 2 in the section containing classification rules for each of the classes.

Where packing groups are allocated to a UN Number, that packing group is indicated in column 5 of the Dangerous Goods List.

The packing group of N.O.S. mixtures and solutions will depend on the degree of danger as determined by the classification tests carried out by the shipper/product supplier. Some N.O.S entries are listed under more than one packing group because the composition of mixtures is variable, and may have a greater or lesser concentration of the dangerous substance in the mixture. The multiple entries make sense because the packing group affects the type of packaging, and may change the packaging requirements.

Where a packing group exists, it must be included on the cargo booking and in the shipper's declaration/ transport document, but does not need to be displayed on packages.

B7 Articles containing dangerous goods N.O.S.⁹⁸

Articles containing dangerous goods may be classified under the PSN for the dangerous goods they contain or in accordance with IMDG 2.0.6.

An "article" could be machinery, apparatus or other devices containing one or more dangerous goods (or residues thereof) that are an integral element of the article, necessary for its functioning. They must be assigned to the appropriate class determined by the hazard(s) present using, where applicable, the Precedence of Hazards table in 2.0.3.6 for each of the dangerous goods contained in the article.

Any subsidiary hazards must be representative of the primary hazard posed by the other dangerous goods contained within the article.

The provision for articles containing dangerous goods do not apply to:

- articles for which a more specific proper shipping name already exists in the Dangerous Goods List of Chapter 3.2; and
- dangerous goods of class 1, class 6.2, class 7 or radioactive material contained in articles.

⁹⁷ IMDG Code, 2020 Edition Amendment 40-20, Sections 2.0.1.3

⁹⁸ IMDG Code, 2020 Edition Amendment 40-20, Section 2.0.6

For articles which do not have an existing proper shipping name and which contain only dangerous goods within the permitted limited quantity amounts specified in column 7a of the DGL, UN 3363 and SP301 of Chapter 3.3 apply.

B8 Determination of flashpoints for flammable liquids

The flashpoint is the lowest temperature at which a flammable liquid produces vapour which can be ignited by a naked flame or spark. Liquids classed as Class 3 flammable liquids in the UN classification system have a flashpoint of 60°C or below. It is the shipper's responsibility to determine the flashpoint in the classification process, and to include it in the shipper's declaration.

Liquids with a flashpoint above 60°C are not regarded as flammable liquids by the IMDG Code.

Descriptions of substances with a sub-hazard of Class 3 are also required to include the flashpoint in the document.

Flashpoints for technically pure Class 3 substances are displayed in Column 17 of the Dangerous Goods List. Flashpoints for N.O.S. substances depend upon the component parts of the substance, and the shipper must determine the flashpoint by product testing and declare the finding in his shipper's declaration.

B9 Special controls for polymerizing and unstable substances stabilized for transport

Substances that are chemically unstable such as self-reactive substances, organic peroxides and substances liable to polymerize shall not be accepted for transport unless stabilization precautions have been taken to prevent the possibility of a dangerous exothermic decomposition or polymerization.

Stabilization may require temperature control or addition of stabilizing chemicals, or a combination of both. Control and emergency temperatures must be specified on the shipper's booking information and in the transport document for temperature controlled transport. Additionally, the word "STABILIZED" must be included on the transport document.

Note: for substances which have the word 'Stabilized' added as part of the proper shipping name in accordance with 3.1.2.6, stowage category D and SW1 (protected from sources of heat) will apply.

If stabilization is by temperature control the words "TEMPERATURE CONTROL" must also be added to the proper shipping name as per 3.1.2.6.2.

Carriage of temperature controlled dangerous goods is likely to be subject to monitoring at sea, so deck stowage is usually required that allows temperature checks and direct access for emergency response.

Polymerizing substances may be found in Class 2 (Gases), Class 3 (Flammable liquids), Class 6.1 (Toxic) and Class 8 (Corrosive). Polymerizing substances that do not meet the criteria for other hazard classes are allocated Class 4.1. These are subject to special carriage conditions⁹⁹.

Control temperature

Control temperature is the maximum safe temperature at which self-reactive or polymerizing dangerous goods that are sensitive to temperature should normally be carried. It is set at a margin below the Self-Accelerating Decomposition Temperature (SADT), and if this temperature is exceeded, intervention and possible cargo jettison will be considered.

⁹⁹ IMDG Code, 2020 Edition Amendment 40-20, Sections Special Provision 386 and 7.3.7

Emergency temperature

The temperature at which substances required to be carried at a controlled temperature become unstable, will spoil or begin to react dangerously and should trigger alarm systems.

B10 Dangerous goods forbidden for transport

Substances or articles that are liable to explode, dangerously react, produce a flame or dangerous evolution of heat or dangerous emission of toxic, corrosive or flammable gases or vapours under normal conditions of transport are prohibited.

The following Special Provisions identify substances that are forbidden for carriage by sea under the IMDG Code: Special Provisions 349, 350, 351, 352, 353 and 900¹⁰⁰.

Note: there are instances in other special provisions whereby certain substances may be prohibited for transport depending on certain criteria. If there are any special provisions applicable to a substance or article being shipped these must always be checked.

B11 Additional certification that may be required from the shipper

B11.1 Weathering certificate¹⁰¹

Some substances are safe to ship only after a period of weathering following production, to allow chemical reaction or internal self-heating to stabilize. Certification should be provided by the shipper to confirm that a sufficient period of weathering has been allowed before shipment.

Requirement for a weathering certificate appears in the IMDG Code Dangerous Goods List under column 17 Properties and Observations. For example, UN 1376, IRON OXIDE, SPENT mentions that 'this substance should have been cooled and weathered for not less than eight weeks before shipment, unless packed in a metal drum'.

B11.2 Exemption certificate¹⁰²

Some substances included in the IMDG Code Dangerous Goods List are not hazardous under certain circumstances, and do not need to be treated as dangerous goods. Example: UN 1362, CARBON, ACTIVATED is listed as "spontaneously combustible". However, production methods for activated carbon vary, and some production processes produce activated carbon that is not self-heating and therefore the product is not subject to the IMDG Code.

If the shipper claims that his product is not hazardous and should therefore be exempt from IMDG rules for any reason, a certificate from the competent authority of the country where the product is made explaining why his product should be exempted is likely to be requested by the shipping company. A copy of this certificate should be attached to the transport documents to travel with the load to avoid potential difficulties with inspection authorities and at transshipment ports.

B11.3 Letter of indemnity

Letters of indemnity form no part of the IMDG Code, but shipping line policy may request the shipper to supply one as a condition of acceptance for controlled temperature dangerous goods. These generally state that while the line will carry out due diligence to care for the machinery in the cargo transport unit controlling the temperature, the line bears no responsibility for consequences of failure or malfunction of that machinery, or that the shipper bears full liability for any consequences arising from the nature of the substance carried.

¹⁰⁰ IMDG Code, 2020 Edition Amendment 40-20, Section 1.1.3

¹⁰¹ IMDG Code, 2020 Edition Amendment 40-20, Section 5.4.4.1.1

¹⁰² IMDG Code, 2020 Edition Amendment 40-20, Section 5.4.4.1.2

B11.4 Competent authority approval¹⁰³

There are occasional circumstances when shippers request a shipment to be made under conditions that are prohibited by the IMDG Code, but are nevertheless considered safe, because special compensatory measures have been taken. In such cases the shipper is entitled to request the competent authority of the country of shipment to judge the measures, and, if found satisfactory, to issue a certificate of approval for the shipment to go ahead. The competent authority will consider the request and only if convinced that there is no increased risk to safety, will issue a certificate of approval. This must be sent to the shipping line and a copy must travel with the goods.

B11.5 Tank inspection certificates

There are no provisions in the IMDG Code to provide packing certificates when dangerous goods are loaded into tank containers. The equivalent for tanks is a “filling certificate” issued when the tank is filled to state that the tank is compatible with the product and has been filled and closed correctly. There is no requirement in the IMDG Code for the shipper to provide a filling certificate.

However, many shipping lines request a copy of the tank inspection certificate. This is a certificate issued after a mandatory tank inspection carried out when tanks are first commissioned and at 2.5 yearly intervals thereafter to state that the tank is in good condition and meets the design specifications.

B12 Provisions for empty uncleaned tank containers

Note: Filling and carriage of filled tank containers are outside the scope of this guide, but the following key points are worth noting:

- Empty uncleaned tanks and MEGCs that have carried dangerous goods are still classed as dangerous goods until the tank has been cleaned and purged¹⁰⁴.
- Depending upon the tank design, empty uncleaned tanks may contain hundreds of litres of residue.
- A dangerous chemical/air vapour mixture may remain in the tank that may present a high risk of explosion of the tank in a fire, until the tank has been cleaned.
- Empty uncleaned tank containers must be declared and documented with the class and UN Number and described as “EMPTY UNCLEANED” or “RESIDUE LAST CONTAINED” on the cargo booking and shipper’s declaration¹⁰⁵.
- Empty uncleaned tanks must display the UN Number, marks and placards of the dangerous goods as if the tank were full.

B13 Provisions for shipping dangerous goods in Limited Quantities¹⁰⁶

B13.1 General advantages of shipping in Limited Quantities

Many shippers choose to consign their goods under the Limited Quantities provisions when permitted by the IMDG Code because such goods are subject to less stringent packaging, marking and labelling requirements and fewer of the restrictions for transport by road and sea. This makes Limited Quantities attractive to manufacturers and shippers of dangerous goods products that are mass-produced for the consumer market and packaged for retail display and sale.

¹⁰³ IMDG Code, 2020 Edition Amendment 40-20, Chapter 7.9.2

¹⁰⁴ IMDG Code, 2020 Edition Amendment 40-20, Section 4.2.1.5, 4.2.2.6, 4.2.3.5 and 4.2.4.7

¹⁰⁵ IMDG Code, 2020 Edition Amendment 40-20, Section 5.4.1.4.3.2

¹⁰⁶ IMDG Code, 2020 Edition Amendment 40-20, Chapter 3.4

B13.2 IMDG advantages of shipping in Limited Quantities

For sea transport, the main advantage is that the segregation restrictions between classes are relaxed for dangerous goods in Limited Quantities. In practice, this means that packages of different classes of dangerous goods shipped in Limited Quantities, normally required to be segregated and shipped in separate cargo transport units, may be shipped in the same shipping container, provided they are in separate packages. This greatly simplifies the distribution supply chain for organisations servicing retail outlets.

One segregation factor is not relaxed – different classes of dangerous goods that are regarded as incompatible must not be packed into the same outer package, even in Limited Quantities.

B13.3 Rationality of allowing relaxed rules for Limited Quantities

The safety rationale for allowing relaxations for the transport of dangerous goods in Limited Quantities is based on risk assessment. By replacing large packagings (e.g. a 200 litre drum) with a number of very small ones (e.g. 200 x 1 litre receptacles), and then placing the receptacles into outer packaging, the potential hazard and, therefore, the risk is measurably reduced. The potential spillage scale is reduced from 200 litres to 1 litre if one package becomes punctured.

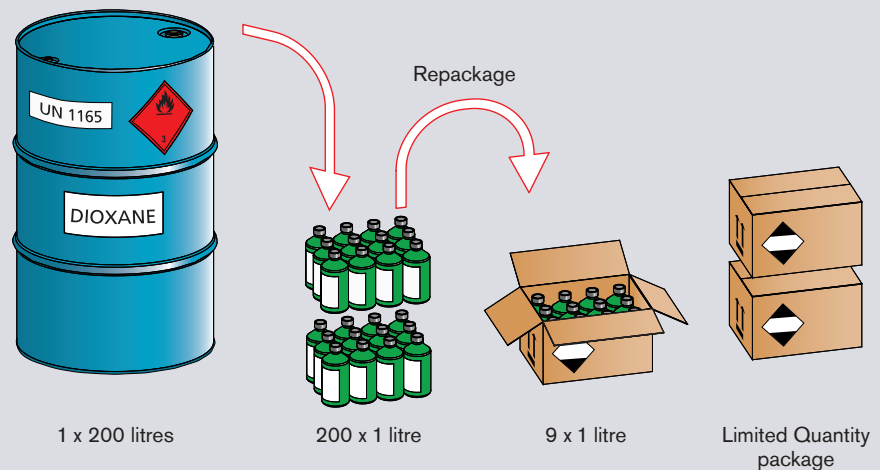

B13.4 Rule variations for dangerous goods in Limited Quantities

The IMDG Code requirements for packaging, marking, labelling and documentation of dangerous goods in Limited Quantities are different from those of “normal” dangerous goods consignments. This section explains what those differences are.

B13.5 Packaging for Limited Quantities¹⁰⁷

Packaging requirements for goods shipped by sea as Limited Quantities are less stringent than for other dangerous goods:

- Packaging does not have to be UN-tested, but it must not leak, and must be built to fulfil the general packaging design criteria of IMDG Part 4
- Substances in receptacles must be in a two-part combination package comprising inner packagings placed inside outer packagings. Intermediate packaging is optional and the gross mass of the package must not exceed 30 kg (see below for exception to this)
- Robust articles in Limited Quantities such as aerosols are not required to be packed in inner receptacles and may be placed directly into outer packagings or in shrink-wrapped trays that meet the general packaging requirements of IMDG Part 4.

¹⁰⁷ IMDG Code, 2020 Edition Amendment 40-20, Section 3.4.2

Intermediate packaging is not required provided the article is not likely to break during transport. Shrink-wrapped trays must not exceed 20 kg

- The maximum mass for solids and capacity for liquids of the inner package is variable and determined by the UN Number and the packing group. The allowable maximum mass/capacity for inner packaging for each UN entry is displayed in column 7(a) of the Dangerous Goods List. If the mass/capacity of the inner packaging exceeds this figure, the goods cannot be classified as Limited Quantities
- There is no upper limit to the total number or weight of packages in Limited Quantities that may be packed to a cargo transport unit – a single shipping container may be packed to its maximum safe working load with packages of dangerous goods in Limited Quantities
- Limited Quantities packages may be made up into units, for instance, shrink-wrapped onto pallets

B13.6 Package marking requirements for Limited Quantities

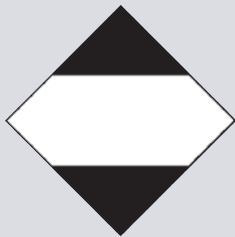

The marking requirements for packages of Limited Quantities are less stringent than for “normal” dangerous goods¹⁰⁸.

Each package must be marked with the Limited Quantities mark (see illustration) regardless of class.

- There is no requirement to mark packages with the Proper Shipping Name, UN Number, or apply the hazard class label or marine pollutant mark
- Inner packagings do not need to be marked or labelled because the outer packaging should not be opened in transit
- Packages containing liquids must display orientation arrows on opposing sides

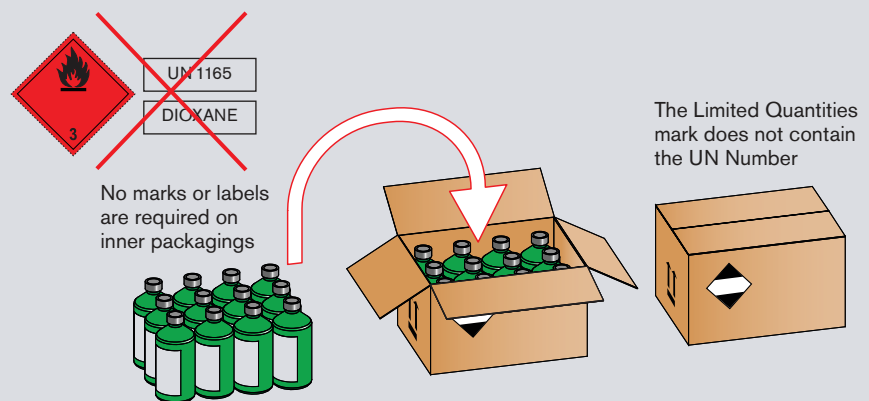

B13.7 Documentation requirements for Limited Quantities

Dangerous goods consigned in Limited Quantities must be documented with a signed shipper's declaration stating the number and type of packages, UN Number, Proper Shipping Name, Class, Packing Group etc in the normal way, but in addition, the declaration must be supplemented with words “LTD QTY” or “DANGEROUS GOODS IN LIMITED QUANTITY” after the dangerous goods description.

Dangerous goods in Limited Quantities packed in cargo transport units need a packing certificate in the normal way.

¹⁰⁸ IMDG Code, 2020 Edition Amendment 40-20, Section 3.4.5

B13.8 Marking requirements for cargo transport units carrying dangerous goods in Limited Quantities

Shipping containers of dangerous goods in Limited Quantities only should not display any hazard class(es) placards or UN Numbers, but they should instead display the Limited Quantities mark 250 mm x 250 mm on both sides, front and back.

B13.9 Summary of criteria for shipping Limited Quantities

There are conditions for allowing dangerous goods to be classified as Limited Quantities. The general rules are as follows:

- There is a maximum permissible mass/capacity to be determined for the inner packaging, variable depending upon the UN Number, shown in column 7a of the Dangerous Goods List. If '0' is shown in that column it is not permitted to be shipped in Limited Quantities
- Dangerous goods must be in PG II or PG III only
- Dangerous goods in PG I are prohibited as Limited Quantities (with minor exceptions)
- Must be in a combination package – inner packaging placed inside an outer packaging (with exception for articles in shrink-wrapped trays)
- There is a maximum allowable mass for the complete packaging (see below)
- There is no upper restriction on the overall number of packages of dangerous goods meeting the requirements of the Limited Quantities rules that may be shipped in a cargo transport unit
- Different classes of dangerous goods in Limited Quantities may be only shipped in the same package provided the segregation rules of IMDG 7.2 indicate they are compatible, and the goods will not react dangerously with each other
- Dangerous goods of classes that are not compatible according to IMDG 7.2 may be shipped in the same shipping container provided they are in Limited Quantities and in different outer packages

Note: To check if dangerous goods can be shipped as Limited Quantities you need to know details of the inner and outer packaging sizes.

B14 Excepted Quantities¹⁰⁹

Dangerous goods may be shipped in Excepted Quantities which allows exemptions from many of the IMDG Code rules for very small packages (less than 30 grams or 30 mLs per inner packaging).

Dangerous goods of medium and low hazard in Packing Groups II and III may be shipped as Excepted Quantities but not high hazard goods of Packing Group I. This is intended to simplify transport of goods traditionally shipped in very small packages such as retail perfumes, cosmetics, personal care items and medicines without application of many of the normal IMDG Code requirements.

Only the following provisions of the IMDG Code apply regarding goods in Excepted Quantities:

- Training
- Classification including Packing Group criteria
- Packagings must meet the general packaging standard of IMDG Part 4, but packagings do not need to be UN tested

¹⁰⁴ IMDG Code, 2020 Edition Amendment 40-20, Chapter 3.5

- The normal documentation requirements of IMDG 5.4

The segregation provisions of the IMDG Code do not apply to goods in Excepted Quantities.

An alphanumeric code in Column 7b of the Dangerous Goods List indicates whether a substance may be shipped as Excepted Quantities. “E0” shown in Column 7b indicates that goods are not permitted to be shipped as Excepted Quantities.

However, there are stipulations for packaging. There must be inners of restricted size packed into outers with intermediate cushioning material capable of absorbing any liquid spillage from the inner packaging, and the complete package as prepared for transport must pass the drop and stack tests described in IMDG 3.5.3.

Consignments of dangerous goods in Excepted Quantities must be documented in the normal way with the words “Dangerous goods in Excepted Quantities” added.

Goods indicated as E1, E2, E3, E4 or E5 in Column 7b of the Dangerous Goods List may be shipped as Excepted Quantities provided the packaging thresholds in the following table are not exceeded:

Code	Max net quantity (grams or mLs or water capacity of gas container) per inner packaging	Max net quantity (grams or mLs or water capacity of gas container) per outer packaging
E0	Not permitted	Not permitted
E1	30	1000
E2	30	500
E3	30	300
E4	1	500
E5	1	300

There are further exemptions from IMDG Code rules for some categories of dangerous goods in Excepted Quantities if the packages contain 1 gram or 1 mL or less of product¹¹⁰.

The number of packages in a single cargo transport unit containing dangerous goods in Excepted Quantities shall not exceed 1000 packages.

B14.1 Marking requirements for Excepted Quantities

Packages must display the Excepted Quantities mark as shown, with the Class number. If the name of the consignor or consignee is not shown on the package, one of the other must be shown on the mark. No marking is required for the cargo transport unit.



* Class number

** Name of the consignor or consignee

¹¹⁰ IMDG Code, 2020 Edition Amendment 40-20, Section 3.5.1.4

B15 Fumigated cargo transport units¹¹¹

B15.1 Purpose of fumigation

Many cargo transport units carrying non-hazardous cargoes and some carrying dangerous goods cargoes are fumigated while in transit by road and sea. Fumigation was traditionally done to eliminate insect and bacteriological infestation in foodstuffs, textiles and packaged goods, but has been extended to sterilisation of timber pallets, packaging and dunnage to comply with national phytosanitary control regulations enacted to prevent the accidental introduction of alien species that attack forests, crops or native indigenous species.

B15.2 Hazards of fumigation

A fumigated unit is a closed cargo transport unit packed with cargo that is under fumigation. Fumigation is done by introducing solid or liquid materials that produce gases that are highly toxic (commonly Phosphine) or asphyxiant, then sealing the container. The result is a cargo transport unit that is highly dangerous to enter, and potentially dangerous to load below deck in certain types of ship because of the risk of toxic gas escaping from the containers and injuring crew in occupied parts of the ship.

Ships need to be aware of which containers are under fumigation so that appropriate stowage arrangements can be made and precautions taken.

Failure to declare fumigated units to the line is a breach of the IMDG Code and if discovered on the quay can lead to short shipment of containers, delays in port, and prosecution of shippers by enforcement agencies. Shippers who consign fumigated units should carefully observe this section of the guide to ensure that proper procedures are followed.

It is imperative that shippers notify the shipping line of any cargo transport unit to be shipped under fumigation when making the booking.

B15.3 Definition of “fumigated cargo transport unit”

A fumigated unit (containing toxic or asphyxiant gas for fumigation) is classified as dangerous goods under the IMDG Code as follows:

UN 3359, FUMIGATED CARGO TRANSPORT UNIT, CLASS 9

A fumigated unit is subject to the IMDG Code until it has been ventilated by opening the doors or by mechanical extraction until no harmful concentration of gas remains.

B15.4 IMDG operational requirements for fumigated cargo transport units¹¹²

Due to the highly dangerous nature of the fumigant gases used, the IMDG Code specifies conditions for transporting fumigated units. These are contained in IMDG 5.5 and in Special Provision 302 and the IMO “Recommendations for the Safe Use of Pesticides in Ships”.

B15.5 Applying the fumigant to the cargo transport unit

Fumigation should be done according to the provisions of IMO publication “Recommendations for the Safe Use of Pesticides in Ships” as amended. Only cargo transport units that can be effectively sealed to prevent escape of gas can be used for fumigation in transit. (Note: closed type cargo transport units can be sealed by

¹¹¹ IMDG Code, 2020 Edition Amendment 40-20, Chapter 5.5 (guidance is also provided in the IMO/ILO/UNECE Code of Practice for Packing of Cargo Transport Units (CTU Code), Annex 9)

¹¹² IMDG Code, 2020 Edition Amendment 40-20, Chapter 5.5

applying adhesive tape over air vents and around door seals). Fumigant shall not be applied to a cargo transport unit once it has been loaded aboard a ship.

B15.6 Marking of fumigated cargo transport units¹¹³

Fumigated units shall display the following warning mark on the outside of the doors until such time as the cargo transport unit has been ventilated and no dangerous levels of gas remain inside. Then the fumigation warning mark (illustrated) shall be removed. The mark shall indicate:

- Type of fumigant used
- Date of application
- Time of application
- Date of ventilation (if ventilation has been done)

Note: Fumigated units are not required to display Class 9 placards to indicate the fumigation hazard. Placard requirements for other dangerous goods that are carried as cargo in a fumigated unit will be required in the normal way, in addition to the fumigation mark on the doors shown below:

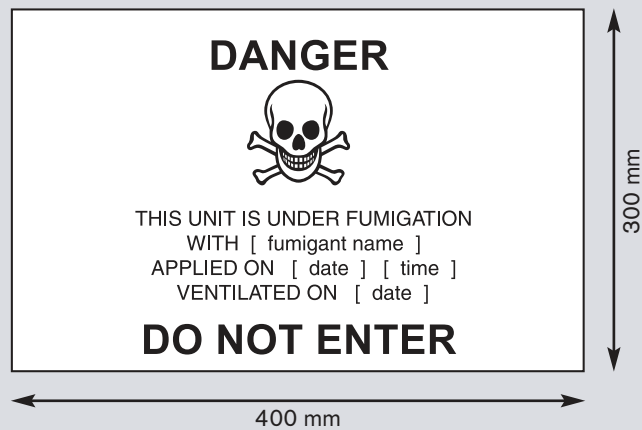

B15.7 Documentation for fumigated cargo transport units¹¹⁴

The shipper should present the shipping line with a document that indicates the following information*:

- UN 3359
- FUMIGATED CARGO TRANSPORT UNIT
- Class 9
- Type of fumigant used
- Amount of fumigant used
- Date and time of fumigation
- Instructions for disposal of any residual fumigant or fumigation device**

*Note 1: A dangerous goods declaration must be made and presented in the normal way for any dangerous goods in the cargo. This may be totally separate from documents providing information on fumigation.

There is no requirement to present fumigation information on a UN-type dangerous goods declaration, although these are often used and are good for the purpose, as they are readily identifiable as dangerous goods information. A certificate of fumigation from the fumigation company that applied the fumigant is also acceptable.

**Note 2: Disposal of residue: Some fumigant materials are solid plates or tablets that break down to a powdery residue as they release toxic gas over a period of time. When the shipping container is unpacked, these residues should be removed from the container and disposed of with care, as they may be capable of releasing gas on movement or exposure to air.

¹¹³ IMDG Code, 2020 Edition Amendment 40-20, Section 5.5.2.3

¹¹⁴ IMDG Code, 2020 Edition Amendment 40-20, Section 5.5.2.4

B15.8 Loading fumigated cargo transport units to ships¹¹⁵

Due to the seriousness of the hazards arising from fumigated units, the IMDG Code has instructions for the ship, that are summarised below:

- The master shall be informed prior to loading any fumigated unit
- Fumigated cargo transport units shall be carried on ships in accordance with the IMDG Code provisions for UN 3359 and MSC.1/Circ.1361 Revised recommendations of the safe use of pesticides in ships
- Fumigated units shall not be allowed onboard until sufficient period of time has elapsed to allow a uniform concentration of gas throughout the cargo in it. This period will vary according to the type of fumigant and nature of the cargo
- When fumigated units are stowed under deck, equipment for detecting fumigant gas(es) shall be carried on the ship with instructions for their use

¹¹⁵ IMDG Code, 2020 Edition Amendment 40-20, Section 5.5.2.5

Case study

Liability judgment in 'MSC Flaminia'¹¹⁶

The judgment in 'MSC Flaminia' found that extensive information available concerning the stability of the commodity was ignored and not disclosed to the carrier. The judge found that, "Disaster was a foreseeable result".

Facts

Many will be aware of the essential facts behind this incident aboard 'MSC Flaminia'. In mid- July 2012, the ship was crossing the Atlantic from the United States bound for Antwerp, Belgium, having left New Orleans, Louisiana some fourteen days earlier, laden with containerised cargo.

Alarms began sounding early on the morning of 14 July, alerting the crew to a smoky cloud rising from one of the cargo holds. Firefighting procedures were initiated, but an explosion cost the lives of three crewmembers and the fire continued to burn for a number of weeks whilst the ship remained at sea.

In an earlier part of the complex and protracted proceedings, the Court had determined that the explosion was the result of runaway auto-polymerization of cargo consisting of divinylbenzene (DVB), stowed in the hold. Having reached a conclusion on the causation, the court set out to establish the responsibilities between the parties remaining in the proceedings, being essentially the owner, manager and operator interests in the ship itself, the shipper of the DVB, and both the freight forwarder and NVOCC involved.

A case note of this nature can hardly do justice to the range of arguments and counter-arguments raised between the parties; the judgment is recommended reading, providing detailed analysis of the facts, logistics industry processes, and the interface of mandatory regulations and contractual terms. Most important, however, is the clear application of the law.

Analysis

Relying heavily on the decision in 'DG Harmony'¹¹⁷, the judge stated the breach of the duty of care "may arise both from a failure to conform with regulatory requirements, or with standard industry or reasonable practice", neatly balancing the interface of obligations under regulation and general negligence. As a consequence, it was found reasonable for the carrier to assume that the cargo was "manufactured and had been delivered in a manner that would allow it to arrive safely at an overseas destination under normal voyage conditions"; there was no expectation, absent additional warning, that the carrier be aware of "dangers greater than those detailed in the International Maritime Dangerous Goods (IMDG) Code". By extension, a shipper has a duty to "warn the carrier of dangers posed by the cargo". Importantly, the judge concluded that there is "nothing in the IMDG Code [stating] that a shipper and NVOCC may not provide additional information".



¹¹⁶ In re M/V MSC Flaminia No.12-cv-8892 (KBF) www.leagle.com/decision/infcdco20180911a96
Originally published as TT Talk "Legal eagle: the consequences of foreseeability" on 15 January 2019.

¹¹⁷ On 9 November 1998, the M/V DG HARMONY caught fire off the coast of Brazil following an explosion in its third hold. The fire rendered the ship and its cargo a constructive total loss.

While the commodity was, at the time of the shipment, correctly classified as Class 9, UN 3082¹¹⁸, this was a generic listing that, absent more specific information, denoted that the goods did not present dangers covered by any of the other classes. However, the circumstances were found to be other than “normal, reasonably anticipated conditions” in that, contrary to the shipper’s own internal protocols, the shipment was authorised to be loaded in a hotter location, with no additional measures, such as specific temperature monitoring or carriage in refrigerated containers.

These factors were compounded by the NVOCC with deficient system infrastructure, on which there was misguided reliance, and poor training together with a misunderstanding that industry practice sees the Dangerous Goods Declaration (DGD) as the “primary source of safe handling information for dangerous goods”, rather than the Safety Data Sheet that may typically accompany the bill of lading/carriage document. Critically, the DGD needs to contain sufficient information to warn the carrier and permit appropriate actions, including stowage decisions.

Decision

The court found that the shipper failed to take account of the nature of the cargo and specific circumstances of this shipment. The NVOCC failed to act on the extensive information available from the shipper and specifically, did not disclose key information about the cargo to the carrier. Following this reasoning, both the shipper and NVOCC were found strictly liable under US Carriage of Goods by Sea Act (COGSA), because while the carrier was aware of the generic dangers posed by the cargo, it did not have “sufficient and relevant information” (and hence no responsibility) for the specific additional hazards presented.

The judge went further to analyse the bill of lading terms, finding specific obligations in relation to dangerous goods and a full indemnity (including “all reasonable legal expenses and costs”) in favour of the carrier.

Comment

This case may be rare in that the shipper and NVOCC were substantial US resident entities. Not only did the evidence build sufficiently to pin liability to them, but there were none of the common pitfalls concerning enforcement of the judgment (once quantum has been determined).

The MSC Flaminia case remains, at the date of publication of this guide, under appeal.

The clear messages for shippers concern compliance with their own procedures, and ensuring that actions are considered and justifiable. The court was equally clear that NVOCCs are exposed where their negligence causes or contributes to a loss that is foreseeable.

Utilising the bill of lading provisions was particularly favourable to the carrier since it presents the potential (in the US) to recover beyond the scope of COGSA alone.



¹¹⁸ Classification for DVB was subsequently changed in Amendment 38-16 to Class 4.1 (Flammable solids, self-reactive substances, solid desensitized explosives and polymerizing substances), UN 3532

References

IMDG Code Amendment 40-20

The references in this guide apply to IMDG Code Amendment 40-20 that entered into mandatory force on 1 June 2022 and remains until 31 December 2023, but may have been applied voluntarily from 1 January 2021.

The previous Amendment, 39-18, may no longer be used after 31 May 2022. This and all previous versions should not be used and any reliant corporate procedures updated as appropriate.

The IMDG Code is updated by the International Maritime Organization with a new Amendment every two years, based on the UN Recommendations on the Transport of Dangerous Goods Model Regulations, a guidance document developed by the United Nations to harmonise dangerous goods transport regulations.

- Transition year when either amendment is valid
- Year when a single amendment is valid

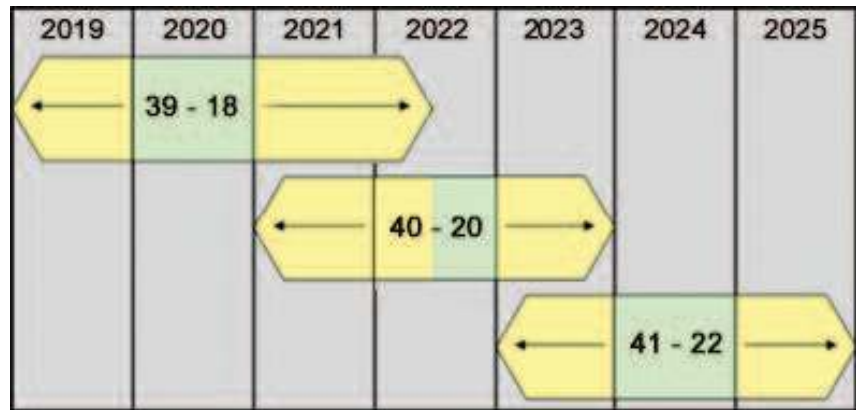

The International Maritime Dangerous Goods Code (IMDG Code) is published by the International Maritime Organization, 4 Albert Embankment, London SE1 7SR

IMO/ILO/UNECE Code of Practice for Packing of Cargo Transport Units (CTU Code), 2014

CTU Code Sales number IC284E, ISBN 978-92-801-1629-8

The CTU Code is available in print and electronic versions from the IMO, ILO and UNECE websites. The IMO website¹¹⁹ includes subsequent material. The UNECE website¹²⁰ maintains searchable pages and links to language versions. The CTU Code is thus available in Arabic, Chinese, English, French, German, Russian and Spanish.

Fumigation guidance

“Recommendations on the Safe Use of Pesticides in Ships” available from the International Maritime Organization in the IMDG Code Supplement.

“Fumigation of ships and their Cargoes” guidance on fumigation published by the UK P&I Club is available free of charge from the UK Club website¹²¹.

¹¹⁹ <https://www.imo.org/en/OurWork/Safety/Pages/CTU-Code.aspx>

¹²⁰ <https://unece.org/transportintermodal-transport/imoilounece-code-practice-packing-cargo-transport-units-ctu-code>

¹²¹ <https://www.ukpandi.com/media/files/uk-p-and-i-club/loss-prevention/carefully-to-carry/carefully-to-carry-consolidated-2018.pdf> (ukpandi.com)

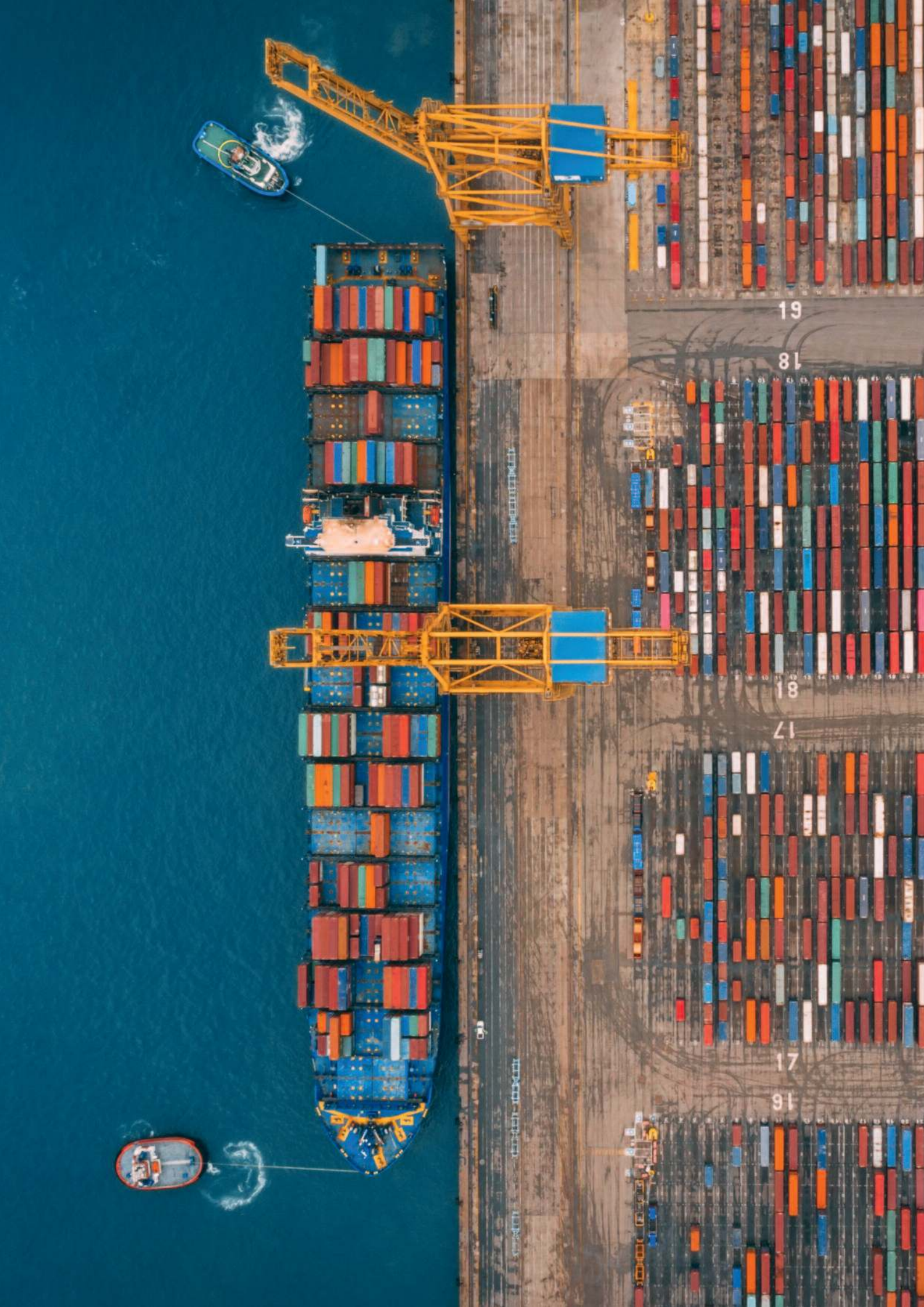

Checklists

This section contains three checklists intended for easy photocopying. They are based on IMDG Code processes and are included to assist shippers and container packers to carry out key functions in the correct way:

Shipper's dangerous goods declaration checklist

This provides a guide to key pieces of dangerous goods information the shipper must include on his dangerous goods declaration.

Consolidator's dangerous goods training and procedure checklist

This is a simple management checklist consisting of a number of questions a container consolidator/packer may ask about his own organisation in regard to the way dangerous goods are handled. The questions are a way of identifying which people carry out particular operations on a given site, how they do it, whether they do it correctly in terms of the IMDG Code, and whether they have been given adequate materials, information, supervision and training to carry out their tasks properly. The aim is to help to identify any knowledge or procedural gaps in the system, so that management can take corrective measures.

Dangerous goods container packer's checklist

This provides a guide to information the packer should have, the checks he should make on dangerous goods packages and the shipping container before he starts packing a container, and the physical and documentary processes he should follow to comply with the IMDG Code during and after packing.

Shipper's dangerous goods declaration checklist

Note: this checklist is not exhaustive and is only applicable where relevant. Other information may be required depending on the commodity being carried.

Consignment reference no:

Have you completed the following information? Tick as appropriate

Entered shipper's name and address

Entered consignee's name and address

Entered journey details:

Port of loading

Port of destination

Final destination

Name of ship

Entered number and type of packages for each UN Number

Entered dangerous goods details for each UN Number:

UN Number

Proper Shipping Name

Class

Entered additional information, where applicable, for each UN Number according to the IMDG Code:

Sub-Hazard

Packing Group

Flashpoint

Marine pollutant

Control temperature

Emergency temperature

NEC

Entered quantity details for each UN Number:

Net dangerous goods cargo mass

Gross dangerous goods cargo mass

Gross mass including tare weight of container

Completed the shipper's declaration:

Entered the name of your company

Entered your name and job title

Entered the date and place where you created the document

Entered the signature of the responsible person

Consolidator's dangerous goods training and procedure checklist

This is a checklist to confirm that you have sound operating procedures. Tick as appropriate

- | | |
|---|---|
| <input type="checkbox"/> Do you know who receives dangerous goods into your site? | <input type="checkbox"/> Is anyone responsible for checking shipping containers before packing? |
| <input type="checkbox"/> Are they trained to check documentation and package marking? | <input type="checkbox"/> Have they been trained in what to check for? |
| <input type="checkbox"/> Does anyone keep a record of dangerous goods on your site? | <input type="checkbox"/> Have forklift operators been trained in IMDG Code segregation? |
| <input type="checkbox"/> Is the record kept up-to-date? | <input type="checkbox"/> Have forklift operators received training in packing dangerous goods and non-hazardous cargo into containers? |
| <input type="checkbox"/> Is the location recorded? | <input type="checkbox"/> Is anyone responsible for ensuring that packages have been secured inside the shipping container? |
| <input type="checkbox"/> Do your personnel palletise/re-package/shrink-wrap dangerous goods packages, or put them into overpacks? | <input type="checkbox"/> Have they been trained to secure cargo? |
| <input type="checkbox"/> Have they been trained to mark and label the packages to IMDG rules? | <input type="checkbox"/> Are timber, plywood sheet and securing materials available? |
| <input type="checkbox"/> Are packing plans prepared for cargo transport units? | <input type="checkbox"/> Are tools available for cutting timber and plywood sheets? |
| <input type="checkbox"/> Do you know who controls packing of dangerous goods into shipping containers? | <input type="checkbox"/> Are people trained to use them? |
| <input type="checkbox"/> Do they have access to the IMDG Code rules? | <input type="checkbox"/> Are container manifests prepared? |
| <input type="checkbox"/> Have they been trained to understand IMDG Code segregation? | <input type="checkbox"/> Are manifests checked to include all the dangerous goods? |
| | <input type="checkbox"/> Do you know who is responsible for applying hazard warning placards and marks? |
| | <input type="checkbox"/> Have they been trained? |
| | <input type="checkbox"/> Is the stock of placards and marks adequate? |
| | <input type="checkbox"/> Are seals applied and seal numbers recorded? |
| | <input type="checkbox"/> Are packing certificates completed and signed? |
| | <input type="checkbox"/> Have the persons authorised to sign the packing certificates been trained and do they understand the legal significance of packing certificates? |

Dangerous goods container packer's checklist

Container no:

Have you completed the following information? Tick as appropriate

- | | |
|---|---|
| <input type="checkbox"/> You have received the shipper's dangerous goods declaration | <input type="checkbox"/> Check you have removed old redundant placards and marks from the container |
| <input type="checkbox"/> The details on the dangerous goods declaration agree with the labels on the packages | <input type="checkbox"/> Check that the date on the container safety approval plate is valid, or that the plate is marked with "ACEP" |
| <input type="checkbox"/> The shipper has signed the shipper's declaration | <input type="checkbox"/> Create a packing plan for packers to follow |
| <input type="checkbox"/> Packages or drums are not leaking | <input type="checkbox"/> If packing different types (different UN Numbers) of dangerous goods, check IMDG segregation rules before packing |
| <input type="checkbox"/> Packages show the correct: | <input type="checkbox"/> Distribute the cargo weight evenly along the container |
| <input type="checkbox"/> Proper Shipping Name | <input type="checkbox"/> Place dangerous goods packages nearest to the doors |
| <input type="checkbox"/> UN Number | <input type="checkbox"/> Fill all gaps between packages or effectively secure and brace packages to ensure that packages inside the container cannot move |
| <input type="checkbox"/> Class label | <input type="checkbox"/> Secure the doors |
| <input type="checkbox"/> Sub-hazard label (if applicable) | <input type="checkbox"/> Fix security seal to the doors and carefully record the seal number on the dangerous goods document |
| <input type="checkbox"/> Marine pollutant mark (if applicable) | <input type="checkbox"/> Enter the container number on the dangerous goods document |
| <input type="checkbox"/> UN Packaging code (unless Limited Quantities) | <input type="checkbox"/> Fix the correct placards and marks to the outside of the container on both sides, front and back |
| <input type="checkbox"/> Limited Quantities diamond mark (if applicable) | <input type="checkbox"/> Sign the packing certificate |
| <input type="checkbox"/> Excepted quantities mark (if applicable) | <input type="checkbox"/> Ensure that the dangerous goods document and packing certificate are passed to the ship with the container |
| <input type="checkbox"/> Orientation arrows (if applicable) | |
| <input type="checkbox"/> You understand the nature of the hazard from the labels | |
| <input type="checkbox"/> You have inspected the condition of the container before packing: | |
| <input type="checkbox"/> Check for residue | |
| <input type="checkbox"/> Check for nails in floor | |
| <input type="checkbox"/> Check for holes | |
| <input type="checkbox"/> Check for excessive damage | |

About us

UK P&I Club

UK P&I Club is a leading provider of P&I insurance and other services to the international shipping community. Established in 1865, the UK P&I Club insures over 240 million tonnes of owned and chartered shipping through its international offices and claims network. 'A (Stable)' rated by Standard & Poor's with free reserves and hybrid capital of \$597m, the UK P&I Club is renowned for its specialist skills and expertise that ensure 'best in class' underwriting, claims handling and loss prevention services.

www.ukpandi.com

TT Club

TT Club is the international transport and logistics industry's leading provider of insurance and related risk management services. Established in 1968, the Club's membership comprises ship operators, ports and terminals, road, rail and airfreight operators, logistics companies and container lessors. As a mutual insurer, the Club exists to provide its policyholders with benefits, which include specialist underwriting expertise, a worldwide office network providing claims management services, and first class risk management and loss prevention advice.

www.ttclub.com

Thomas Miller

UK P&I Club and TT Club are managed by Thomas Miller, an independent and international provider of market leading insurance services. Most of the businesses we currently own or manage are acknowledged leaders in their chosen market. Our portfolio includes mutual organisations and, increasingly, specialist insurance services businesses.

www.thomasmiller.com

Helping customers to provide **Compliance, Efficiency and Safety** in their operations for over 35 years with a mission of

SAFETY OF LIFE AND CARGO AT SEA



Compliance: our IT systems and e-learning courses help companies in the transport chain to ship in compliance with the IMDG Code and other regulations

Efficiency: our innovative solutions help customers to deliver a faster, more accurate service to their customers

Safety: the ultimate goal is safety in the supply chain-our solutions can really help to stop incidents at sea

OUR INNOVATIVE SOLUTIONS INCLUDE:

Hazcheck Validation: we offer a range of IT systems for every link in the sea transport chain which help to automate compliance checks for declared dangerous goods cargo and process shipments in a more efficient and safe manner. Used by 9 of the top 10 containers lines.

Hazcheck Detect: an API based, integrated cargo screening tool for the identification of misdeclared and undeclared dangerous goods. It screens cargo using libraries of keywords and rules, developed with industry to detect non-compliant cargo in seconds.

IMDG Code e-learning: web-based Amdt 40-20 IMDG Code training for shore side staff involved in the handling and transport of dangerous goods by sea

CTUPack e-learning: web-based training for those loading/unloading containers

Visit www.existec.com/solutions for more information

ICHCA
INTERNATIONAL



e-learning course sponsors
and supporters



t +44 (0)1325 466672
e sales@existec.com
w www.existec.com



ukpandi.com
ttclub.com